

2021-2769

2022-09-20

Device Label

AUTOPILOT® CHLORSYNC® CS30  
CHLORINE GENERATOR  
CONTROLS ALGAE  
in

Swimming Pool (Spa) Waters

Domestic

A maximum of 113 m<sup>3</sup> liters (30k gal) of pool water or 97 m<sup>3</sup> liters (25k gal) of spa water can be treated with one AutoPilot® ChlorSync CS30 unit.

Maximum output of hypochlorous acid equivalent to 0.49 kg of free available chlorine per day.

WARNING: Staining of pool (spa) surfaces may occur due to deposit of copper salts. Excessive levels of copper will increase the probability of this occurrence.

For swimming pools, a range of 1-3 ppm of free available chlorine must be maintained.

For spas a range of 3-5 ppm of free available chlorine must be maintained.

READ THE LABEL AND OPERATING MANUAL BEFORE USING

KEEP OUT OF REACH OF CHILDREN

REGISTRATION NO. 34563 *PEST CONTROL PRODUCTS ACT*

WARNING: Operating the AutoPilot® ChlorSync without water flow through the cell can cause a buildup of flammable gases, which can result in FIRE OR EXPLOSION.

AquaCal AutoPilot, Inc.,  
2737 24<sup>th</sup> St N.,  
St Petersburg, FL 33713, USA

Cell Label

CHLORSYNC® REPLACEMENT CELL CS30

Replacement electrode for the chlorine generating device AutoPilot® ChlorSync® CS30 REGISTRATION NUMBER XXXXX, PEST CONTROL PRODUCTS ACT. This cell must only be used on this model of chlorine generating device.

Read the Label, the Installation Manual and Operation Manual of the chlorine generating device AutoPilot® ChlorSync® CS30 before using.

AquaCal AutoPilot, Inc  
2737 24<sup>th</sup> St North,  
St Petersburg, FL 33713, USA

# ChlorSync®

## Owner's / Installation Manual



### ***Important!***

This manual covers the installation and operation of the ChlorSync® Chlorine Generators. Read this manual and product labels before installing or operating this equipment.

INSTALLER: THIS DOCUMENT IS PURCHASER'S PROPERTY AND IS TO REMAIN WITH THE EQUIPMENT OWNER

LTP0127 REV 2.0



# Table of Contents

---

<b>Safety Information</b>	
Safety Information	1
<b>General Information</b>	
Contacting AquaCal AutoPilot, Inc.	4
How Your Chlorinator Works	4
Quick Start	4
ChlorSync® Model Cell Options	5
Power Center	5
Cell	6
Flow Bypass Kit (Optional)	7
Patented Temperature Compensation	7
<b>Control Panel Overview</b>	
User Display	8
Salt Indicator LED	8
Cell Indicator LED	8
Flow Indicator LED	8
Cell Output Control	9
<b>Water Balance and Chemistry Recommendations</b>	
Basic Water Chemistry	10
Preparing the Pool/Spa Water	13
Using the Saturation Index	14
Adding Salt	15
Salt Addition Information	15
<b>Operation</b>	
Basic Operation	16
Sanitizer Output Settings and Adjustments	17
<b>Maintenance</b>	
Cleaning the Cell	17
Winterizing	18
Spring Start Up	18
Fuse Replacement	18
<b>Installation</b>	
Electrical Installation	19
Pool Cover Detection	20
PoolSync™ Installation (optional equipment not included)	20
Plumbing Installation	22
Installation Recommendations	22
Connecting the ChlorSync® Cell Cable to the Power Center	23
Installing the Optional Flow Bypass Kit	24
<b>Troubleshooting</b>	
Troubleshooting	25
<b>Specifications and Approvals</b>	
Agency Approvals	28
FCC Compliance	28





## SAFETY INFORMATION

### Safety Information

## IMPORTANT SAFETY INSTRUCTIONS

When installing and using this electrical equipment, basic safety precautions should always be followed, including the following:

## READ AND FOLLOW ALL INSTRUCTIONS

- A green colored terminal or terminal marked G, GR, Ground, Grounding, or the symbol  is located inside the power center terminal box or compartment. To reduce the risk of electric shock, this terminal must be connected to the grounding means provided in the electric service panel with a continuous copper wire equivalent in size to the circuit conductors supplying this equipment.
- Follow all state, local, and National Electrical Code(s) (provincial and Canadian Electrical Code(s) if applicable) unless local guidelines supersede.
- For personal safety, and to avoid damage to equipment, follow all safety instructions displayed on the equipment and within this manual. Repair and service of your chlorinator must be performed by qualified service personnel.
- Should you suspect your chlorine generator is not performing properly, refer to the Troubleshooting section in this manual to determine if service is required.
- Warranties may be voided if the chlorinator has been improperly installed. Failure to properly operate, maintain or repair the AutoPilot® chlorinator may void the factory warranty.

### **SAFETY SIGNALS**

*Throughout this manual, safety signals are placed where particular attention is required.*



**WARNING** - Failure to heed the following may result in permanent injury or death.



- WARNING** - Failure to heed the following may result in permanent injury or death.
- **RISK OF ELECTRICAL SHOCK** - Disconnect all AC power when installing or servicing this system. Follow all state, local, and National Electrical Code(s) (provincial and Canadian Electrical Code(s) if applicable). Use copper conductors only.
  - **RISK OF ELECTRICAL SHOCK** - To reduce the risk of electrical shock, replace damaged cord immediately.
  - **RISK OF ELECTRICAL SHOCK** - The AutoPilot® chlorinator contains no owner-repairable components. Repairs must not be attempted by untrained and/or unqualified individuals. If service is deemed necessary, contact installing dealer or AquaCal AutoPilot Customer Support.
  - **RISK OF ELECTRICAL SHOCK** - A bonding lug has been provided on the outside of the power center. This lug permits the connection of a No. 8 AWG (8.4 mm<sup>2</sup>) solid copper-bonding conductor (No. 6 AWG in Canada). Make this connection between the AutoPilot® power center and all other electrical equipment and exposed metal within 5 ft (1.5 m) of the unit. All field-installed metal components (such as rails, ladders, drains, etc.) within 12 ft (3.6 m) of the pool, spa, or hot tub, must be bonded to the equipment grounding bus using copper conductors not smaller than No. 8 AWG (8.4 mm<sup>2</sup>) (No. 6 AWG in Canada).



- RISK OF ELECTRICAL SHOCK - The AutoPilot® chlorinators must be installed at least 10 ft (3 m) from the pool or spa wall.

- RISK OF ELECTRICAL SHOCK - A disconnect device incorporated into the fixed wiring must be included in the supply circuit (such as a time clock, relay, or circuit breaker).
- RISK OF ELECTRICAL SHOCK - Connect only to a branch circuit protected by a ground-fault circuit-interrupter (GFCI). Contact a qualified electrician if you cannot verify that the circuit is protected by a GFCI.
- RISK OF ELECTRICAL SHOCK - The chlorinator must be connected only to a supply circuit that is protected by a ground-fault circuit-interrupter (GFCI). The GFCI must be tested on a routine basis. To test, push the GFCI test button. Power should be interrupted. Push the reset button. Power should be restored. If the GFCI fails to operate in this manner, it is defective.
- RISK OF ELECTRICAL SHOCK - If the ground-fault circuit-interrupter (GFCI) interrupts power to the equipment without the test button being pushed, a ground current is flowing with a possibility of an electrical shock. Do not use equipment. Disconnect the equipment and have the problem corrected by a qualified service representative before using.
- RISK OF ELECTRICAL SHOCK - The unit has two bonding lugs marked "Bonding Lugs" that are provided on the external surface or on the inside of the power supply terminal box or compartment. To reduce the risk of electric shock, connect the local common bonding grid in the area of the hot tub or spa to these terminals with an insulated or bare copper conductor not smaller than No. 6 AWG.

## SAVE THESE INSTRUCTIONS

**⚠ WARNING** - Failure to heed the following may result in permanent injury or death.

- CHEMICAL HAZARD - To avoid damaging splashes, always add acid to water, never water to acid. Wear safety glasses and use other appropriate personal protection equipment.
- CHEMICAL HAZARD - Always follow the instructions on the manufacturer's label whenever handling or using chemicals.
- CHEMICAL HAZARD – Heavy pool (or spa) usage and higher temperatures may require a higher chlorine output in order to maintain proper free available chlorine residuals.
- WATER CHEMISTRY SAFETY - Improper water chemistry can present a serious health hazard. The proper residual chlorine level and water chemistry must be maintained. The addition of certain pool maintenance chemicals can reduce the effectiveness of chlorine. Maintain pool/spa water per standards detailed later in this manual.
- WATER CHEMISTRY SAFETY Do not use this device with bromide products
- COMBUSTIBLE HAZARD – The AutoPilot® chlorinator is equipped with an electronic flow sensor that automatically turns the unit off in the event of a “low water flow” situation. Do not tamper in any way with this safety feature.
- PERSONAL SAFETY HAZARD – To reduce the risk of injury, do not permit children to operate this device.
- RISK OF CHILD DROWNING OR INJURY - Children must be closely supervised at all times around pool or spa equipment.

**⚠ CAUTION** - Failure to heed the following may result in equipment damage.

- The ChlorSync® must be installed and operated as specified. Failure to do so will void the equipment warranty.
- To permit proper air circulation, the power center must be mounted at least 5 ft (1.5 m) above ground level or any other air flow obstruction.
- Special measures are required in the event of freezing conditions. Your chlorinator may be damaged if measures are not taken in advance of freezing conditions. Equipment damage due to freezing conditions is NOT covered under the equipment warranty.
- For all newly constructed or resurfaced plaster pools: Do not operate the AutoPilot® with newly poured or resurfaced pool plaster. Before adding salt and operating the chlorinator, wait 30 days after construction is completed to allow proper curing of the surface material. Follow the pool surface manufacturer's guidelines for your specific pool.
- FOR NEW VINYL LINER POOLS, contact the manufacturer for recommended instructions before adding salt and operating the ChlorSync®.
- Do not allow granular salt to pile up in one location without brushing, as staining may occur.

- While the recommended level of salt for your AutoPilot® product should not damage your equipment, excessively high chlorine levels can cause corrosion damage to pool/spa fixtures and equipment. Consult your pool/spa professional for equipment selection, proper use and maintenance of these products.
- For maximum cell life, maintain water in a balanced condition. Water maintained in a scaling condition will shorten cell life and may render the AutoPilot® chlorinator inoperative. Damage and/or service calls caused by improper water balance, is NOT covered under the equipment warranty. See "*Water Balance and Chemistry Recommendations*" on page 9 for more information.
- Scraping or scratching the titanium blade's edge or surface will damage the blade coating and cause premature failure of the cell. Never use any sharp or metallic objects to remove scale. The warranty will be voided. See "*Cleaning the Cell*" on page 17 for instructions on how to properly clean the cell.
- The ChlorSync® reverse polarity times are factory set and can only be changed by using the PoolSync™ option. Reduced polarity reversing cycle times will reduce cell life and should only be used due to uncontrollable scale formation on the cell. ALWAYS test and adjust water balance, before attempting scale control via shortening reverse period.

## SAVE THESE INSTRUCTIONS

## GENERAL INFORMATION

### Contacting AquaCal AutoPilot, Inc.

If you need to contact AquaCal AutoPilot, Inc. for questions, service, or parts, please have your model and serial numbers available. Also have the name of your installer and date of your equipment's installation. Please refer to our website for the latest manual revisions, additional information, and helpful service advice.

Website	www.autopilot.com
Phone	(727) 823-5642
Fax	(877) 408-8142
Address	AquaCal AutoPilot, Inc. 2737 24th Street North St. Petersburg, FL 33712, USA

Pool volume (Gallons / Liters)	
Installer	
Install Date	
Cell Type Cell Serial #	



### How Your Chlorinator Works

The ChlorSync® is designed to handle the purification needs of residential and small commercial swimming pools and spas. The amount of chlorine required for proper sanitization will vary based on the pool/spa size and factors such as water temperature, bather load, exposure to direct sunlight, and special water features.

The system requires a low concentration of dissolved salt (sodium chloride) in the water and is normally maintained below the taste threshold. The AutoPilot® unit uses the salt to generate chlorine, which your pool/spa requires to remain sanitized. The chlorine reverts to salt after treating the water. Since the chlorine generation process does not reduce pool/spa water salinity, there is minimal loss during a swimming season. Salt can be lost due to filter back washing, rainwater overflow, leaks, or bather splashing/carry out, but not through evaporation.

The water circulation pump must be operating for your chlorinator to produce chlorine, so run time is one of several key factors to maintaining proper sanitizer levels. Most installations require a minimum of eight (8) hours-per-day pump run time to properly filter and sanitize the water.

### Quick Start

1. Balance the water chemistry according to the water chemistry parameters and salt recommendations. See "*Water Balance and Chemistry Recommendations*" on page 9. See "*Preparing the Pool Water*" on page 13.
  - The chlorinator may be started immediately. The salt reading, however, may initially be inaccurate until the circulation pump has been run for 24 hours to fully dissolve newly added salt.
2. Use the  or  arrow buttons to set the purifier percentage to 50%.
3. During the first two weeks, test the water chemistry parameters every 3 - 4 days. Adjust purifier percentage as needed.
4. Once ideal purifier percentage has been determined, follow normal maintenance procedures.

## ChlorSync® Model Cell Options

The ChlorSync® system consists of the following components.

- Part #ECP0312 Power Center- Provides power and controls communication between the power center and the cell.
- Three different cell options to choose from- CS30, CS40, CS50.

The chlorine output for each of the ChlorSync® models, which is based on a 24-hour chlorinator/pump run time and a salt concentration of 3,500 ppm (mg/L), is listed in the table below.

Model	Chlorine output lbs. (kg) per 24 hours
ChlorSync® CS30	1.1 lbs. (0.50 kg)

## Power Center

**⚠ WARNING - Failure to heed the following may result in permanent injury or death.**

- RISK OF ELECTRICAL SHOCK - All electrical connections should be made by a licensed electrician or certified electrical contractor.
- RISK OF ELECTRICAL SHOCK - Disconnect all AC power when installing or servicing this system.
  - Follow all state, local, and National Electrical Code(s) (provincial and Canadian Electrical Code(s) if applicable). Use copper conductors only.
- RISK OF ELECTRICAL SHOCK - Before plugging or unplugging the ChlorSync® to the power center, first switch off the AC power to the power center.

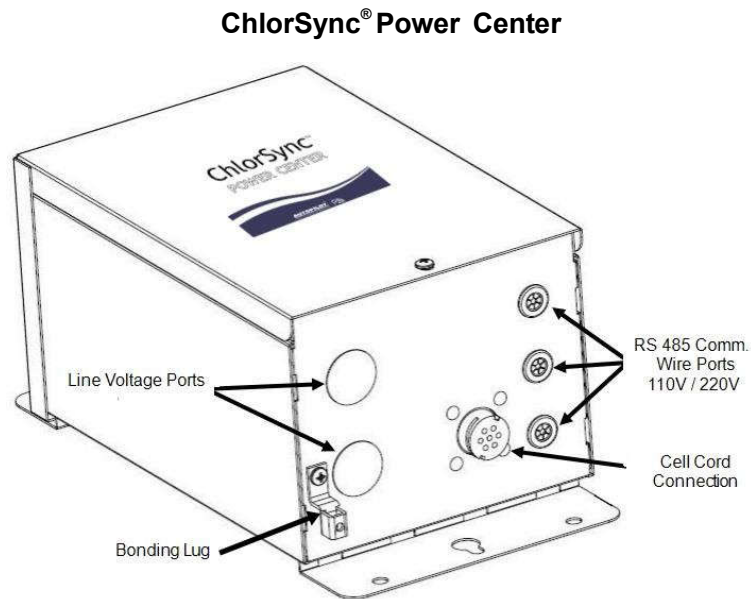

Figure 1

The cell includes buttons, a digital display, and LED indicators to control the ChlorSync® and chlorine production. See "*User Display*" on page 8 for more information. The ChlorSync® unit measures water flow, water temperature and salt levels. If the salt level in the pool/spa water falls below 2,300 ppm (mg/L), the unit will not produce chlorine until more salt is added to the body of water. The cell is equipped with a self-cleaning feature that reverses the cell polarity and removes normal calcium build up. The self-cleaning process occurs at predetermined times throughout the day.

If the water is excessively unbalanced and scale forming, the self-cleaning process may not be able to remove all scale. See "*Water Balance and Chemistry Recommendations*" on page 9.

### ChlorSync® Cell

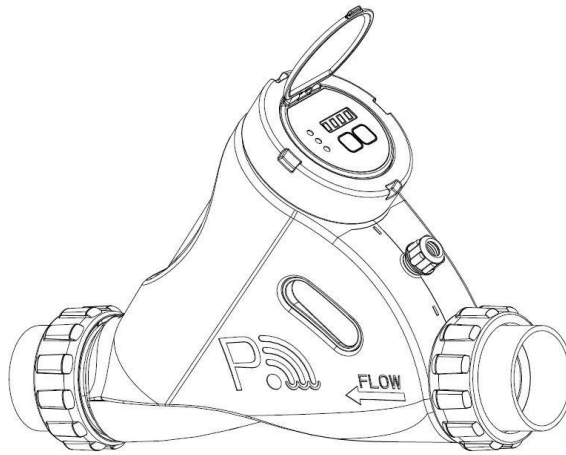

Figure 2

The ChlorSync® sanitizer output can be set by adjusting the output level on the control unit. The pool pump run time, combined with the output setting, will determine how much sanitizer is produced each day.

The unit is capable of monitoring water flow, water temperature, and salt level with the following components:

1. **Flow Sensor:** The cell is equipped with a sensor that will detect flow. If the water flow is not adequate due to improper plumbing or other conditions, the unit will not produce chlorine.
2. **Salt Sensor:** The ChlorSync® will measure the pool/spa water salt level as follows:
  - Every twelve (12) hours during normal operation
  - At system power up or reset
  - When flow is initially detected
  - Once every hour during a low salt condition (less than 2,700 ppm)
3. **Temperature Sensor:** The ChlorSync® uses the temperature sensor to protect the unit from damage caused by extreme cold-water conditions. Chlorine production will be reduced by way of the temperature compensation feature. The chlorinator uses the temperature sensor for the Automatic Temperature Compensation feature described in detail. See "*Patented Temperature Compensation*" on page 7. This feature automatically lowers the chlorine output setting as water temperature decreases and raises output as water temperature increases.

## Flow Bypass Kit (Optional)

The ChlorSync® models are compatible with an optional flow bypass kit. The #STK0240 assembly allows the water flow rate to be slowed through the cell, while permitting the pump to continue to circulate water to-and-from the pool/spa at full flow rates. The reduced water flow through the cell results in a more efficient "Super-Chlorination" effect, resulting in improved overall sanitization.

This bypass kit should be plumbed directly in line with the cell. See installation instructions in the Installations Steps section of this manual.

### ChlorSync® Flow Bypass Kit

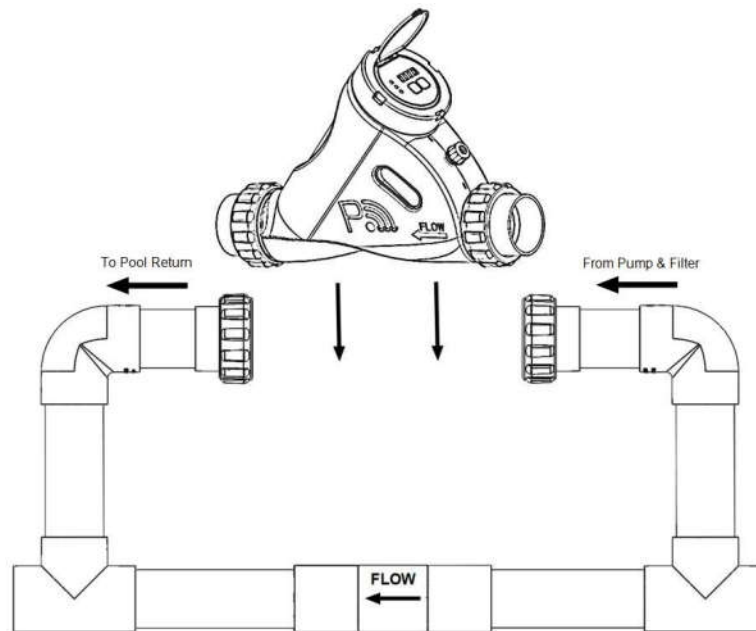

Figure 3

## Patented Temperature Compensation

The ChlorSync® uses the temperature sensor to determine water temperature. This measurement is required for the temperature compensation feature to automatically adjust chlorine output as water temperature varies.

The water temperature sensor works in conjunction with the purifier % feature to automatically adjust chlorine output based upon changes in water temperature. Less chlorine is needed in cold water, so chlorine output is automatically reduced as water temperature drops (avoiding excess chlorine production). Conversely, more chlorine is needed in warmer water, and production is automatically adjusted higher as water temperature increases.

As the water temperature falls below 65°F (18°C), the controller will automatically reduce the purifier % and will reduce the maximum % that can be selected. This feature prevents the controller from generating excessive chlorine in cold water where it is not needed and prevents premature cell failure.

Note: The unit will display the original user specified setting.

## CONTROL PANEL OVERVIEW

### User Display



Figure 4

### Salt Indicator LED

The ChlorSync® checks the pool/spa water salinity on start-up and every 12 hrs. thereafter and displays the levels as follows:

- **Green LED (solid):** Indicates salt level is adequate. Pool water salt level is between 2,700 ppm (mg/L) and 4,500 ppm (mg/L).
- **Green LED (flashing):** Salt level is above 5,000 ppm (mg/L). The unit is still producing chlorine and will not be damaged by high salt conditions.
- **Red LED (solid):** The display shows (LO SALT). The salt level is between 2,300 ppm (mg/L) and 2,700 ppm (mg/L). The unit will generate chlorine, but at a lower output level. See "*Salt Addition Information*" on page 15. Add salt as needed.
- **Red LED (flashing):** The display shows (ADD SALT). The salt level is below 2,300 ppm (mg/L). The unit will not generate chlorine until the minimum amount of salt has been reached. See "*Salt Addition Information*" on page 15. Add salt as needed.
- NOTE: When salt is added, the circulation pump should be run continuously until the salt has been fully dissolved. After the salt is dissolved, reset the power to the power supply. This will allow for accurate measurement of the new salt level.

### Cell Indicator LED

This light indicates the ChlorSync® cell status.

- **Green LED (solid):** The unit is operating normally.
- **Red (flashing):** *The unit is not producing chlorine.* The cell will display the message (CELL) and should be inspected. Conductivity may be reduced due to calcium buildup on the cell blades, low salt, etc. Refer to the Troubleshooting section of this manual for more information.

### Flow Indicator LED



This light indicates water flow through the ChlorSync®.

- **Green LED (solid):** The flow sensor detects adequate water flow to produce chlorine.
- **Red LED (flashing):** The display shows (nO FL0). The flow sensor detects low water flow through the cell. The unit will not produce chlorine without water flow.

## Cell Output Control

The ChlorSync® display will show the selected sanitizer output % and cell polarity during normal operation. The  $\Delta$  or  $\nabla$  buttons are used to adjust the sanitizer output % to the desired level.

When paired with the PoolSync™ option, consult the PoolSync™ app for more information.

### To increase or decrease sanitizer output %:

1. Press the  $\nabla$  button one time to decrease sanitizer output by 1%, or the  $\Delta$  button one time to increase output by 1%. Press and hold for 10% increments or decrements.
2. The current sanitizer output will begin to flash on the display. The sanitizer output can be adjusted at this time.
3. Release the  $\Delta$  or  $\nabla$  button when the desired sanitizer output is reached. The unit will resume normal operation.

The rotating character shown on the left side of the display informs that the unit is generating chlorine. If the rotating character is not present, the cell is not generating chlorine at that time but will do so shortly.

- A clockwise motion denotes forward polarity on the blades and a counter-clockwise denotes reverse polarity.

### Rotating character shown clockwise

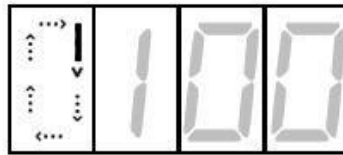

Figure 5

### Boost Mode On/Off

The Boost feature is used to increase the sanitizer output from its normal setting to 100% for a cumulative 24-hour period of circulation pump run time. During this time, the sanitizer output display will show "100%" as well as the hours remaining in the boost period. When the boost period expires or is manually terminated, the sanitizer output % returns to its previous setting and normal operation.

- Press the  $\Delta$  or  $\nabla$  buttons simultaneously to turn Boost Mode on or off.

## WATER BALANCE AND CHEMISTRY RECOMMENDATIONS

Water balance is the relationship between different chemical measurements in your pool/spa water. A pool that is balanced has proper levels of pH, Total Alkalinity and Calcium Hardness. Balanced water can also be defined as water that is not corrosive or scaling. Water that is not balanced can damage equipment and pool/spa surfaces.

Proper water chemistry levels are essential to maintain safe and consistent swimming pool/spa operation. Sanitizers are used to destroy harmful or otherwise objectionable organisms. Stabilizer or Cyanuric Acid (CYA) is used in many regions to reduce unnecessary loss of

chlorine to sunlight. Salt is used by the ChlorSync® to generate chlorine sanitizer.

Please note the following recommended water chemistry parameters are for residential pool/spa applications only. Follow local regulatory guidelines for any commercial pool/spa applications.

Table 1

Parameter	Units	Pool Range	Spa Range
Free Chlorine	ppm (mg/L)	1.0 - 3.0	3.0 - 5.0
Combined Chlorine	ppm (mg/L)	0.0 – 0.02	0.0 – 0.05
pH	-	7.2 – 7.8	7.2 – 7.8
Total Alkalinity	ppm (mg/L)	100 - 120	100-120
Calcium Hardness	ppm (mg/L)	200 - 300	150-200
Salt	ppm (mg/L)	3500 – 4500	3500 - 4500
Cyanuric Acid (Stabilizer)	ppm (mg/L)	30 - 50	30 – 50

Refer to "*Basic Water Chemistry*" and "*Using the Saturation Index*" sections in this manual for further information concerning pool/spa water chemistry maintenance requirements.

See "*Troubleshooting*" on page 25 for assistance with resolving low or high chlorine issues.

## Basic Water Chemistry

The ChlorSync® is designed to produce chlorine on a daily basis. To monitor the system's efficiency, the water chemistry ranges, and a schedule of periodic checks should be followed. See Table 2 on the following page for recommendations.

 **CAUTION** - Failure to heed the following may result in equipment damage.

- Excessively high chlorine levels can cause premature cell depletion and corrosion damage to pool fixtures and equipment.
- Always turn the ChlorSync® unit off before adding chemicals to the pool/spa.
- Never use dry acid to adjust pH in arid geographic areas with excessive evaporation and minimal dilution. A buildup of by-products can damage the cell.
- Always follow the instructions on the manufacturer's label whenever handling or using chemicals.

Table 2

Chemical	Ideal Test Schedule	Effect of Low / High Levels	Corrective Actions
Free Chlorine	Weekly	<u>Low free chlorine</u> : Not enough residual chlorine to safely sanitize pool/spa water.	<u>Low free chlorine</u> : Check for combined chlorine level and shock as necessary. Increase chlorine output to maintain a 2.0 - 4.0 ppm (mg/L) residual. Check stabilizer level and add as necessary.
		<u>High free chlorine</u> : Corrosive to metallic fixtures in pool water. Can bleach swimwear and hair or cause premature chlorinator cell depletion.	<u>High free chlorine</u> : Decrease chlorine output. Let chlorine dissipate normally until 2.0 - 4.0 ppm (mg/L) is achieved. In extreme cases, pool/spa water can be diluted with fresh water or a chlorine neutralizer added. (Diluting will reduce salt and CYA. Check and adjust as needed.)
pH	Weekly	<u>Low pH</u> : (acidic) Equipment corrosion, eye/skin irritation, plaster etching, rapid chlorine consumption.	<u>Low pH</u> : Add sodium carbonate or soda ash.
		<u>High pH</u> : (basic) Scale formation, cloudy water, poor chlorine effectiveness, eye/skin irritation.	<u>High pH</u> : Add sulfuric acid, muriatic acid or sodium bisulfate.
Total Alkalinity	Monthly	<u>Low TA</u> : Eye irritation, pH "bounce", stained, etched plaster and metal corrosion.	<u>Low TA</u> : Add sodium bicarbonate.
		<u>High TA</u> : Constant acid demand, difficulty in maintaining pH, and contributes to scale formation or cloudy water conditions.	<u>High TA</u> : Add sulfuric acid, muriatic acid often or sodium bisulfate more frequently until the TA is within an acceptable range.
Calcium Hardness	Monthly	<u>Low CH</u> : Etching of the plaster, equipment corrosion.	<u>Low CH</u> : Add calcium chloride flakes.
		<u>High CH</u> : Scale formation, cloudy water. Rapid buildup of scale may exceed the system's self-cleaning capability and require manual cleaning of the cell.	<u>High CH</u> : Partially drain and refill pool/spa with fresh water to dilute. (Diluting will reduce salt and CYA. Check and adjust as needed.)
Cyanuric Acid (Stabilizer or CYA)	Monthly	<u>Low CYA</u> : Destruction of chlorine by the UV rays from the sun.	<u>Low CYA</u> : Add cyanuric acid 1 lb. (0.45 kg) per 5,000 gallons (18,930 liters) increases CYA 25 ppm (mg/L).
		<u>High CYA</u> : Requires more chlorine to maintain proper sanitizer levels. Note: CYA is not needed for indoor pools/spas. CYA should be reduced to 30 - 50 ppm (mg/L) for colder climate regions.	<u>High CYA</u> : Partially drain and refill pool/spa with fresh water to dilute. (Diluting will reduce salt. Check and adjust as needed.)
Saturation Index	Monthly	+ 0.3: Water is scale forming. Calcium carbonate is falling out of solution. This rapid buildup of scale may exceed the system's self-cleaning capability and require manual cleaning of the cell.	Balance the pool/spa water as close to an equilibrium of 0 as possible. See " <i>Using the Saturation Index</i> " on page 14.
		- 0.3: Water is corrosive. Water will take away other material it comes in contact with to form a natural balance. These materials can be metallic fixtures, swimwear, etc. Results can also include cloudy water, eye/skin irritation, and poor chlorine effectiveness.	Balance the pool/spa water as close to an equilibrium of 0 as possible. See " <i>Using the Saturation Index</i> " on page 14.
Salt	Monthly	<u>Low Salt</u> : Below 2,700 ppm (mg/L) causes premature cell failure and reduces chlorine production.	<u>Low Salt</u> : Add salt according to digital display on the ChlorSync® unit or salt chart.
		<u>High Salt</u> : Above 6,000 ppm (mg/L) can cause corrosion of metallic fixtures and will taste salty.	<u>High Salt</u> : If undesirably high, partially drain and refill the pool/spa with fresh water. (Diluting will reduce CYA. Check and adjust as needed.)

## **Chlorine**

The desirable form of chlorine is called Free Chlorine. This form of chlorine is responsible for the actual sanitation activity in pools and spas. Free chlorine is highly reactive and, once added to pool/spa water, has a tendency to combine with organic matter in the pool/spa. It quickly attacks pathogens as well as other bather wastes. When chlorine combines, it chemically changes. The chlorine binds to organic matter and is referred to as Combined Chlorine. Combined chlorine is responsible for eye burn and skin irritations. Total Chlorine is the sum of free chlorine and combined chlorine. If a strong chlorine odor is noted, it is due to an excess of combined chlorine. It is important to test total chlorine as well as free chlorine. If there is a difference greater than 1.2 ppm (mg/L), a shock treatment should be initiated.

During peak chlorine demand (summer months, rainy season, or heavy bather usage) it may be necessary to increase your chlorine output by increasing your sanitizer output setting.

Conversely, during low chlorine demand, you can decrease your output to a lower setting. For extremely heavy chlorine demand or to boost your chlorine residual levels quickly, you can supplement with any type of chlorine or non-chlorine shock containing potassium monopersulfate. Avoid using excess amounts of treatments containing sodium bromide.

Note: During cold-water conditions (below 60°F (15.6°C)) chlorine demand is reduced significantly. For colder climate regions with sustained low temperatures, contact your local pool/spa professional for proper pool/spa winterizing instructions.

## **pH**

pH is a term used to refer to the degree of activity of an acid or base in the water. A low pH, acidic or corrosive water, contributes to eye and skin irritation as well as damage to pool/spa equipment. A high pH will result in scaling, cloudy water and ineffective sanitation. Improper pH also contributes to the strong smell, red eyes and dry itchy skin conditions that are usually blamed on “too much chlorine” being in the pool/spa.

## **Total Alkalinity**

Total Alkalinity refers to the ability of the pool/spa water to resist a change in pH. It helps manage or control the pH in the pool/spa. The desired range is 80 to 100 ppm (mg/L). Low alkalinity is aggressive or corrosive and causes the pH readings to fluctuate (pH bounce). High alkalinity may cause cloudy water and scale forming conditions. Your chlorinator does not affect total alkalinity. Factors changing this measure are ancillary chemicals added to the pool/spa and “out of balance” make-up water.

## **Calcium Hardness**

Calcium Hardness is a measure of calcium content in the water. If the calcium content is too high, calcium can drop out of solution, forming scale on equipment. A low level will cause the water to become corrosive as the water tries to naturally form equilibrium. This means the water will “leach” minerals from everything it meets. Damage to equipment and unpleasant swimming conditions result. Your chlorinator does not change calcium hardness. Factors changing this measure are ancillary chemicals added to the pool/spa and “out of balance” make-up water.

## Cyanuric Acid

Cyanuric Acid acts as water “Stabilizer” or “Conditioner”. This chemical goes by either trade name and allows your chlorine residual to last longer by protecting it from the UV rays of the sun. With low cyanuric acid, chlorine can be used up just as quickly as it is generated.

Note: For indoor pool/spas, it is not necessary to maintain a stabilizer level to protect the chlorine from the UV rays.

## Metals

Some metals, i.e., copper and iron, can cause loss of chlorine. Also, metals can stain your pool/spa. Have your local pool/spa professional check for metals and recommend methods of removal. Metal content should be 0 ppm (mg/L).

## Preparing the Pool Water

Installer please note - When properly sized to the site, the AutoPilot® will meet the sanitizer “maintenance” requirements of the pool/spa. The unit is not designed to chlorine shock treat or build up a chlorine residual when starting with a zero or very low chlorine level.

Before starting the chlorinator, the water must be properly balanced, and the chlorine level adjusted to between 2.0 - 4.0 ppm (mg/L) free chlorine. See more on adjusting water balance and start-up chlorine levels earlier in this section.

## Calculating Pool/Spa Volume

To determine the approximate number of gallons or liters in a pool or spa:

1. Determine the surface area.
2. Multiply the surface area by the average depth and the constant conversion factor of 7.5 to convert cubic feet to gallons, or 1,000 to convert from cubic meters to liters.

### Rectangle

- ▮ Area = Length x Width
- ▮ Gallons = area x average depth (ft<sup>3</sup>) x 7.5
- ▮ Liters = area x average depth (m<sup>3</sup>) x 1,000

### Circular

- ▮ Area = Radius x Radius x 3.14
- ▮ Gallons = area x average depth (ft<sup>3</sup>) x 7.5
- ▮ Liters = area x average depth (m<sup>3</sup>) x 1,000

## To determine the approximate number of gallons or liters in a more complex shaped pool/spa:

1. Divide the complex shape into several simple shapes.
2. Calculate each one separately, and then add back together.

Example: An oblong pool can be divided into two radius measurements and one rectangular shape. (R = Radius)

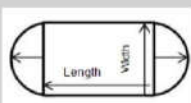

- ▮ Area = Radius x Radius x 3.14 + (Length x Width)
- ▮ Gallons = area x average depth (ft<sup>3</sup>) x 7.5
- ▮ Liters = area x average depth (m<sup>3</sup>) x 1,000

## Using the Saturation Index

This index is used by pool professionals to ensure that your total water chemistry does not fall into a corrosive or scaling condition. Either condition can cause premature damage to the cell, any of your other equipment, as well as your cementitious finish.

The Saturation Index is composed of the following factors:

- pH as tested
- Plus the Temperature factor
- Plus the Calcium Hardness factor
- Plus the Alkalinity factor
- Minus the Total Dissolved Solids factor (in this case the bulk of the dissolved solids are salt)

This is expressed in the formula  $SI = pH + TF + CF + AF - TDSF$  and uses the following charts:

TEMPERATURE		TF	CALCIUM HARDNESS		CF	TOTAL ALKALINITY		AF	SALT LEVEL		TDSF
60°F	15.6°C	0.4	150 ppm (mg/L)		1.8	075 ppm (mg/L)		1.9	0000 - 1000 ppm (mg/L)		12.1
66°F	18.9°C	0.5	200 ppm (mg/L)		1.9	100 ppm (mg/L)		2.0	1001 - 2000 ppm (mg/L)		12.2
76°F	24.4°C	0.6	250 ppm (mg/L)		2.0	125 ppm (mg/L)		2.1	2001 - 3000 ppm (mg/L)		12.3
84°F	28.9°C	0.7	300 ppm (mg/L)		2.1	150 ppm (mg/L)		2.2	3001 - 4000 ppm (mg/L)		12.4
94°F	34.4°C	0.8	400 ppm (mg/L)		2.2	200 ppm (mg/L)		2.3	4001 - 5000 ppm (mg/L)		12.5
103°F	39.4°C	0.9	600 ppm (mg/L)		2.4	250 ppm (mg/L)		2.4	5001 - 6000 ppm (mg/L)		12.6

### Example:

7.8 = pH as measured

0.7 = Temperature is 84°F (TF)

2.4 = Calcium Hardness is 600 ppm (mg/L) (CF)

2.3 = Total Alkalinity is 200 ppm (mg/L) (AF)

12.4 = Salt is 3,500 ppm (mg/L) (TDSF)

**0.8 = Saturation Index.**

**This water is scale forming and needs to be balanced.**

Table 3

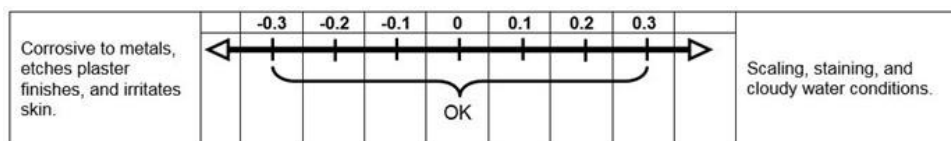

If adjustments need to be made to balance the water, the recommended sequence is as follows:

1. Test and adjust total alkalinity. This may reduce pH so wait at least 8 hours before proceeding.
2. Test again and adjust pH, then
3. Adjust calcium hardness.



## Adding Salt

### Type of Salt to Add

It is important to use Sodium Chloride (NaCl) salt that is greater than 99% pure. Acceptable types of salt include granular food grade, pool salt, water softener pellets, or solar salt flakes. Pool salt or food grade granular salt will dissolve faster than pellets or flakes. Rock salt and Granular Salt with Iodine or Rust Preventatives should not be used, as these mixtures contain high levels of impurities that may cause staining. Granular salts containing anti-caking additives such as YPS (Yellow Prussiate of Soda) or sodium ferrocyanide are not recommended as they can cause a localized tint to the water or yellow staining of the pool/spa finish.

### Amount of Salt Required

Test the water for current salt content first!

The ideal salt range is 3,500 – 4,500 ppm (mg/L). The minimum salt level is 2,300 ppm (mg/L). Salt levels above 6,000 ppm (mg/L) are not normally recommended, as corrosion issues may result. Salt levels below 3,500 ppm (mg/L) will reduce the efficiency of the ChlorSync® and will result in low chlorine production. Extremely low salt levels below 2,300 ppm (mg/L) will activate the low salt safety cut off and will halt chlorine production until salt is replenished to proper levels.

For information on amount of salt to be added relative to the volume of water to be treated vs. existing salt level, refer to the salt addition information in the section below.

### How to Add Salt to Pool/Spa

 **CAUTION** - Failure to heed the following may result in equipment damage.

- For newly plastered pools/spas, do not operate the ChlorSync® SCG for 30 days after construction is completed. You must allow the plaster to cure, otherwise the salt could damage the pool/spa finish.
- Do not allow salt to pile up in one location without brushing, as staining may occur.

The circulation pump should be run continuously until the salt has been fully dissolved. Add salt directly to pool (or spa if a spa-only installation) and over the main drain (if main drain is present). If there is no main drain, a vacuum head may be used to encourage salt circulation. Distributing the salt by brushing is also helpful; brush the salt toward the main drain (if one is present). Set pump operation to normal run time after salt has fully dissolved into water.

If the salt level becomes undesirably high, the only way to remove excess salt is to partially drain the pool/spa and refill with fresh water.

## Salt Addition Information

The salt in the pool/spa is constantly recycled during normal operation. Loss of salt during a swimming season should be minimal. Filter back washing, draining due to rainwater overflow, splashing, bathing suit drag out, and leaks are typical ways salt is lost. Salt does not leave the pool/spa when water evaporates.

1. Determine pool/spa volume in Gallons or Liters.
2. Determine the current salt level in the pool/spa. Some pools/spas may already have a salt residual, so always test water before adding salt. (This can be obtained from the control display or by testing water.)
3. Add salt as per the following formula:
  - Newpool: 50lbs (22.7kg) of salt per 2,000 gallons (7,571 Liters) will raise the salt level by 3,000 ppm (mg/L).

- Example: For a 10,000 gallon (37,854 Liter) pool with a salt level of 500 ppm (mg/L), you would need to add 250 lbs. (113.4 kg) of salt to bring the level up to 3,500 ppm (mg/L).

## OPERATION

### Basic Operation

Note: Upon initial start-up, check sanitizer every 3 - 4 days and make small output level adjustments as necessary to maintain 2.0 - 4.0 ppm (mg/L) free chlorine levels. Keep in mind, your chlorinator does not directly measure or regulate the sanitizer levels in your pool. Rather, the owner/operator will need to periodically test the water to determine the current chlorine level, and adjust the output setting as needed.

This section is a brief explanation of the startup procedure and operating instructions for chlorinator.

After construction is completed and the pool/spa has been filled with water, wait 30 days before adding salt and operating the chlorinator. The salt level should be maintained between 3,500 - 4,500 ppm (mg/L).

When sized properly to the specific body of water and site conditions, the chlorinator is designed to generate daily, an adequate amount of sanitizer to maintain the recommended 2.0 - 4.0 ppm (mg/L) of free chlorine.

With a properly balanced pool/spa that has been pretreated to 2.0 - 4.0 ppm (mg/L) of chlorine, the recommended sanitizer output setting starting point is 50% at start-up of the new system. The sanitizer output % setting refers to the amount of time the cell is energized. The system cycles on-and-off, as indicated by a rotating character on the display.

Use the  $\triangle$  or  $\nabla$  buttons to adjust the sanitizer output percentage to the desired level from 0% to 100%. See "*Cell Output Control*" on page 9 for more information.

#### **If Using a Pool/Spa Pump Timer**

The use of an external pool/spa pump timer is not required.

The water circulation pump must be operating for your ChlorSync® to produce chlorine, so run time is one of several key factors to maintaining proper sanitizer levels. Most installations require a minimum of eight (8) hours-per-day pump run time to properly filter and sanitize the water.

The Pool and Hot Tub Alliance (PHTA) recommends that all water in a residential pool/spa pass through the filtration system at least once every six (6) hours, four (4) turns every 24 hours (referred to as pool water turnover). However, the optimum output setting will vary based upon pool/spa size, location, exposure to sunlight, number of users, vegetation around the pool/spa, water balance practices, temperature and pump run time. Your installer should have already taken these factors into consideration when performing installation programming.

Your pool/spa pump should be set to run as per your pool/spa professional recommendations to achieve proper filtration and optimal chlorine production by your ChlorSync® chlorinator.

Note: At 55°F (13°C) or colder water temperatures, the controller will adjust to a fixed 1% output, thus preventing over-chlorination and premature cell failure.

## Sanitizer Output Settings and Adjustments

1. Power up the ChlorSync® chlorinator.
  2. If flow is present, the salt is measured within ten (10) seconds and the salt LED is properly displayed. If the salt level is below 2,300 ppm (mg/L), the red Salt indicator will be illuminated. The Cell light will be blank, indicating chlorine production has stopped due to low salt conditions.
  3. Press the  $\Delta$  or  $\nabla$  buttons to set the sanitizer output to 50%.
  4. After 24 hours, test the pool/spa water for free available chlorine. Ideally, the free available chlorine should be maintained at 2.0 - 4.0 ppm (mg/L). You can increase the ChlorSync® sanitizer output % if the free chlorine is too low by pressing the  $\Delta$  button. To decrease the sanitizer output, press the  $\nabla$  button.
- During the first two weeks, test the water chemistry parameters every 3 - 4 days. Adjust sanitizer output percentage as needed until the free chlorine is stabilized at 2.0 - 4.0 ppm (mg/L).

## MAINTENANCE

### Cleaning the Cell

**Self-Cleaning:** Your AutoPilot® chlorinator is designed to automatically self-clean calcium scale buildup that may form on the blades during normal operation. However, unbalanced water chemistry can cause a heavy scale buildup exceeding self-cleaning capabilities. Periodic manual cleaning may be necessary. The simplest way to avoid this extra work is to maintain the water chemistry at the levels recommended.

White, flaky, or crusty calcium build up on the edge or between the blades will shorten the life of the cell. If required, clean the cell immediately and determine the cause of scaling.

A small amount of scale accumulation is normal, but if your cell shows excessive scaling on a regular basis, it is recommended to inspect the cell every eight (8) weeks and clean as appropriate. In areas where there is high water hardness, more frequent visual inspection and cleaning may be needed.

**⚠ WARNING** - Failure to heed the following may result in permanent injury or death.

- **CHEMICAL HAZARD** - To avoid damaging splashes, always add acid to water, never water to acid. Wear safety glasses and use other appropriate personal protection equipment.



**⚠ CAUTION** - Failure to heed the following may result in equipment damage.

- Scraping or scratching the titanium blade's edge or surface will damage the blade catalyst coating and cause premature failure of the cell. The warranty will be voided. Never use any sharp or metallic objects to remove scale.

### Cell Cleaning:

1. Turn off the water circulation pump.
2. Power off the ChlorSync® power center and disconnect the cell from the power center.
3. Remove any loose scale with a garden hose using a high-pressure attachment.
4. Place the AutoPilot® Acid Wash Kit part #STK0227 on the end of the cell as shown and hand tighten.
5. Fill the capped cell with water two inches from the top of the cell blades.



Figure 6

6. Fill the rest of the cell with muriatic acid, being careful not to allow solution to overflow onto the outside of the cell. This allows for an approximate 1-to-4 solution. Always add the acid to the water. If you do it the other way around, it may cause the solution to spray back, causing serious injury.
  - If solution does spill over onto the outside of the cell, rinse with water immediately.
  - Sulfuric and no fume acid do not give favorable results and are not recommended.
7. Allow the solution to sit in the cell for fifteen (15) minutes or until the acid stops bubbling.
8. Safely dispose of the solution; pouring it into the pool/spa is recommended.
9. Remove the cap from the cell and rinse with light water pressure; re-inspect the cell, and repeat acid cleaning if the cell is still scaled.

## Winterizing

**⚠ CAUTION** - Failure to heed the following may result in equipment damage.

- Special measures are required in the event of freezing conditions. The ChlorSync® may be damaged if measures are not taken in advance of freezing conditions. Equipment damage due to freezing conditions is NOT covered under the equipment warranty.

During brief freezing conditions, allow the filtration system to run continuously throughout the freeze period. Circulating (moving) water will not freeze. In areas where freezing conditions are prevalent and sustained, the equipment must be winterized as follows:

- Drain water from pump, filter, and all intake and return lines.
- Remove the cell, clean thoroughly and store. Cover open pipe ends once cell is removed to prevent intrusion from debris and small animals.

## Spring Start Up

It is recommended the water be manually chlorine-shocked when first starting up the pool/spa in the springtime. Test water and add the appropriate chemicals to balance the pool/spa water as per the levels recommended in this manual. See "*Water Balance and Chemistry Recommendations*" on page 9. Be sure to check salt and Cyanuric acid (stabilizer), bringing those readings up to the recommended levels. Inspect the cell and test the flow sensor; clean and/or replace those items as necessary.

## Fuse Replacement

**⚠ WARNING** - Failure to heed the following may result in permanent injury or death.

- ELECTRICAL SHOCK HAZARD – Turn off the electrical power to unit before servicing.

### Fuse Location

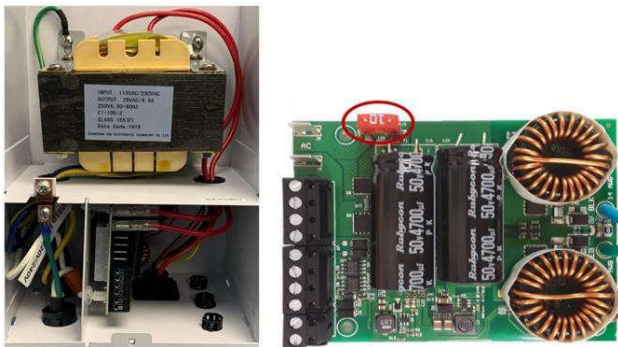

To inspect or replace the fuse, disconnect power, and remove power center cover. See Figure 7 for location of the fuse.

Replace with a standard auto, 10-amp mini blade fuse that is available at most automotive supply stores.

**10 Amp  
Mini Blade  
Fuse**



Figure 7

# INSTALLATION

## Electrical Installation

- ⚠ WARNING** - Failure to heed the following may result in permanent injury or death.
- **RISK OF ELECTRICAL SHOCK** - Disconnect all AC power when installing or servicing this system. Follow all state, local, and National Electrical Code(s) (provincial and Canadian Electrical Code(s) if applicable). Use copper conductors only.
  - **RISK OF ELECTRICAL SHOCK** - All electrical connections should be made by a licensed electrician or certified electrical contractor.

- ⚠ CAUTION** - Failure to heed the following may result in equipment damage.
- Connecting 230 Vac to a unit that has been configured to 110-120 Vac will result in permanent damage to the unit. Damage due to incorrect wiring is not covered under the warranty.

### Mounting the Power Center

Choose a mounting location for the power center that is close to the circulation pump electrical source.

The power center should be mounted in a vertical position on the wall (flat surface), no more than 15 ft. (4.6 m) away from the ChlorSync® cell. The wiring inputs should be facing downward. Electrical conduit (rigid or flexible) must be used and installed as per NEC guidelines.

**Circuit Protection:** Single-pole 20 AMP device for 115V installations, or a two-pole 20 AMP device for 220V installations, at the electrical panel.

**Input:** 95-130 VAC, 50/60Hz, 220 Watts (2 AMP) or 220-240 VAC, 50/60Hz, 220 Watts (1 AMP).

**Output:** 22-39 VDC @ 7.5 AMPS maximum from the power center.

### 110VAC Basic System Wiring

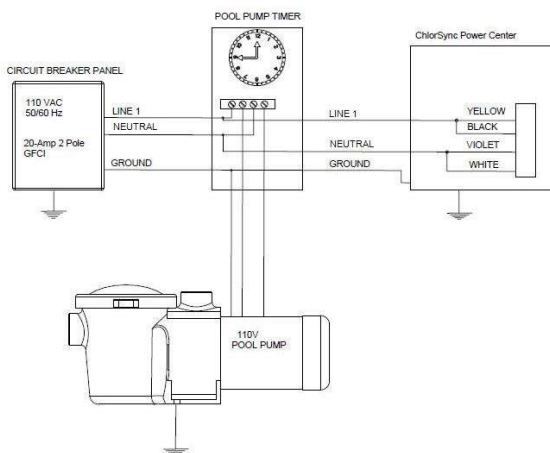

Figure 8

### 220VAC Basic System Wiring

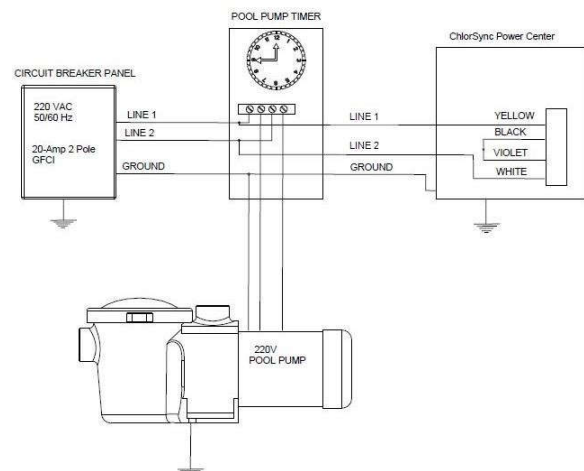

Figure 9

Connect power to the LINE side.

## Pool Cover Detection

The ChlorSync® can support the addition of an automatic pool/spa cover switch (not supplied) that will detect when the pool/spa cover is open or closed. The ChlorSync® will automatically adjust sanitizer output when the cover is closed, avoiding over chlorination or premature cell depletion.

This feature will recognize a signal from the cover switch that is a dry contact connected directly to the power center board. When the pool/spa cover is detected (via the pool/spa cover switch), the unit will automatically reduce the sanitizer output to 5% of the user setting.

Note: The display will continue to show original sanitizer output that was set by the user.

### Terminal Connector Location



Figure 10

## PoolSync™ Installation (optional equipment not included)

The PoolSync™ is an optional device that allows the user to view and control the ChlorSync® via the mobile PoolSync™ app. Key features of the PoolSync™ include:

- Monitor and control purifier output percentage remotely
- Advise as to how much salt to add, when needed
- Monitor current salt level, flow and water temperature
- Notification should the unit need any attention

For more detailed information on features and how to use the app, please see the manual included with your PoolSync™ product. Follow the wiring diagrams provided to connect the PoolSync™ unit to the power center.





## PoolSync™ Device Connection

1. Turn off power to the ChlorSync® unit.
2. Remove the power center cover and the grommet in one of the available openings on the bottom of the box.
3. Insert the strain relief fitting provided with the PoolSync™ device. Route the antenna wire through the strain relief and into the power center.
4. There is one (1) - four position connector and two (2) - two position connectors located on the front of the board for wiring compatible devices. Remove the four-position connector by pulling up on the black plastic body.
5. Connect the stripped end of the wires to the corresponding terminal on the PCB connector as shown in the diagram below.
6. When connection is made, verify the wires are firmly held in place by gently pulling on the wire.
7. Replace the connector onto the PCB header pins. Be sure to align correctly.
8. Tighten the strain relief, replace the power center cover, and restore power to the unit.
9. Before mounting the PoolSync™ to the wall, verify WiFi reception.

- Black wire from PoolSync™ to BLK(or GND)
- Yellow or White wire from PoolSync™ to YEL (or A)
- Green wire from PoolSync™ to GRN(or B)
- Red wire from PoolSync™ to RED(VDC or 10v)

### PoolSync™ Wiring Location

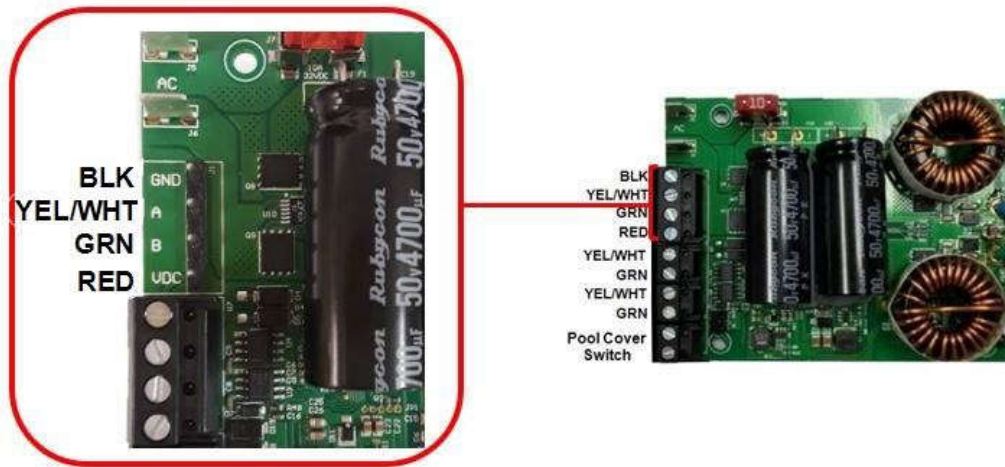

Figure 11

## Plumbing Installation

**⚠ WARNING** - Failure to heed the following may result in permanent injury or death.

- RISK OF ELECTRICAL SHOCK - Disconnect all AC power when installing or servicing this system. Follow all state, local, and National Electrical Code(s) (provincial and Canadian Electrical Code(s) if applicable) unless local guidelines supersede. Use copper conductors only.

This section outlines basic installation of the ChlorSync® to the pool/spa plumbing system. Before attempting the installation, verify the following items have been included with the system.

### Parts Included

- One (1) ChlorSync® cell
- Two (2) cell unions with two (2) o-rings
- Installation and User's Guide (this manual)

### Required Tools for Installation (Not included)

- Phillips and small tipped 1/8" flat head screwdriver
- Pliers or wire strippers
- Hacksaw or pipe cutter
- NSF approved all-purpose PVC / CPVC / ABS cleaner primer and cement

## Installation Recommendations

Figure 12 shows a typical ChlorSync® system installation. Please note this diagram is not drawn to scale.

**⚠ WARNING** - Failure to heed the following may result in permanent injury or death.

- Donot operate the ChlorSync® unit if the cell housing is damaged or improperly installed.

The ChlorSync® should be plumbed into the dedicated pool/spa return line (including pool/spa combination installations) after the filter and heater, if applicable.

The ChlorSync® unit requires a minimum flow rate of 20 gpm (76 L/min). For accurate flow detection, provide at least 12"-18" (30 cm - 46 cm) of straight pipe in front of the cell inlet.

Pipe unions: Maximum pressure 50 psi at 70°F (21°C).

### To Install the ChlorSync® Cell:

1. Measure and cut out a section of plumbing to fit the cell.
2. Attach the PVC unions to the plumbing pipe, using PVC glue. Allow the glue to dry before proceeding to the next step.
3. Orient the cell in a horizontal position. Be sure there is sufficient access to the cell control panel for programming and maintenance.
4. Install the cell onto the unions. Confirm the o-rings are aligned properly to avoid water leaks. Hand tightening is usually sufficient.
5. Confirm water flow through the cell is as per the flow directional arrow markings on the side of the cell.
6. Turn on the circulation pump and check for leaks at the unions.

Note: A bypass kit must be installed for systems with flow rates exceeding 80 gpm (303 L/min).

## ChlorSync® System Installation Example

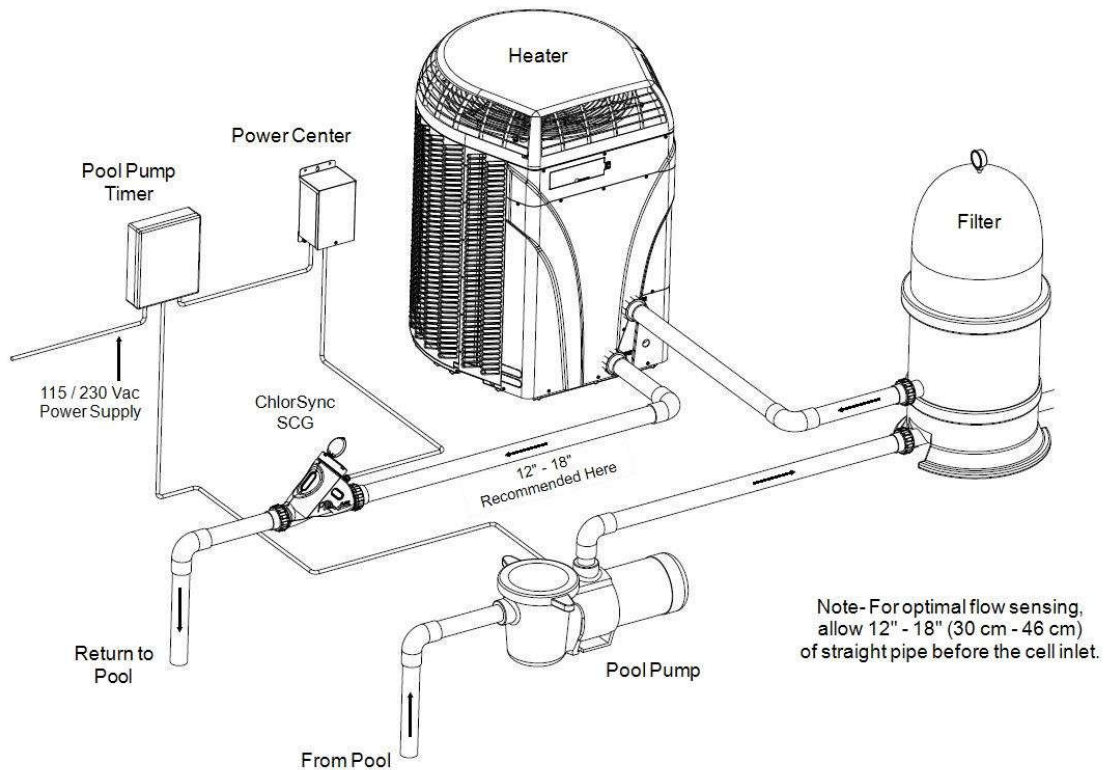

Figure 12

### Connecting the ChlorSync® Cell Cable to the Power Center

- ⚠ WARNING - Failure to heed the following may result in permanent injury or death.**
- RISK OF ELECTRICAL SHOCK - All electrical connections should be made by a licensed electrician or certified electrical contractor.
  - RISK OF ELECTRICAL SHOCK - Disconnect all AC power when installing, before making any connections or servicing this system.

Once the ChlorSync® cell is installed, connect the cell cord to the power center.

1. The AC power should be switched OFF before connecting the power cord to the power center or the

cell may short circuit.

2. Align and insert the six (6) pin cell cord connector with the receptacle on the bottom of the power center. Turn the round nut until it locks the connector in place.

### Cell Cord Connector

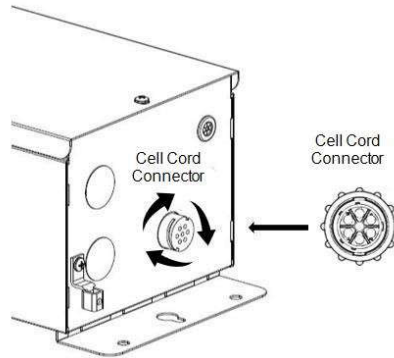

Figure 13

## Installing the Optional Flow Bypass Kit

The bypass kit can be directly plumbed into the system and must be installed so that the loop is facing upward as shown below. This orientation prevents hazardous gas buildup in the system should the flow switch fail to detect sufficient flow.

- The direction of the water flow through the bypass must be as indicated for the system to operate.
- For a pool/spa combination, the manifold must be located as the last component in the pool/spa return line to avoid over-sanitization of the spa.
- If the flow rate for the system is less than 20 gpm (76 L/min), a larger pump must be installed (or steps taken to improve flow rate).
- For a two-speed or a variable speed pump, ensure the pump can provide sufficient flow at the low speed.

### ChlorSync® Flow Bypass Kit

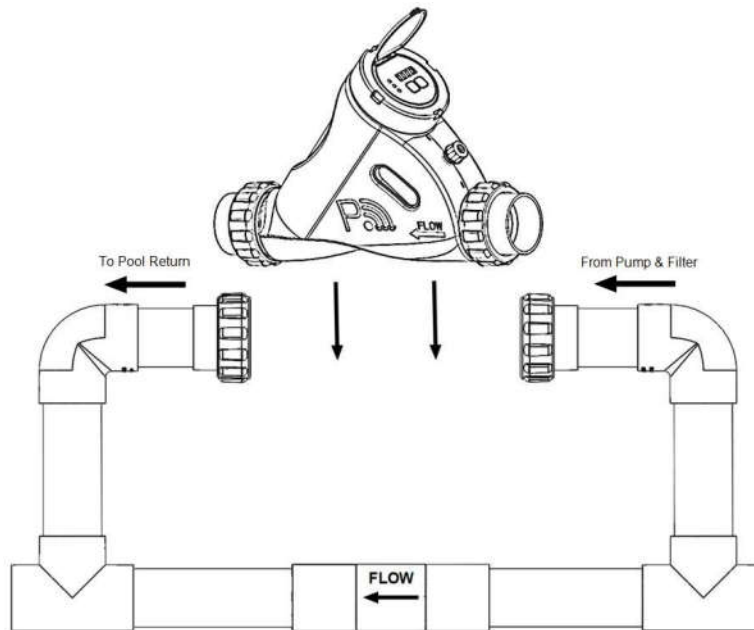

Figure 14

# TROUBLESHOOTING

## Troubleshooting

### Display is Blank

#### Typical Solution

1. No power to the power supply. Check the circuit breaker. If the unit is wired to a time clock, confirm it is turned on.
2. Transformer wiring may be incorrect. Confirm it is wired properly for incoming voltage.
3. The fuse (10A) may have failed. Test and replace as necessary.
4. There may be a problem with the transformer or power supply circuit board. Contact your local service center or AquaCal AutoPilot Customer Support for assistance.

### Normal Display

#### Problem

There are no warning messages on the display, but the chlorine level is too low. Water quality looks dirty or cloudy.

#### Typical Solution

1. Check water balance. See "*Water Balance and Chemistry Recommendations*" on page 9. The Cyanuric acid level may be low, and the chlorine is being consumed quickly by the UV from the sun.
2. The chlorine setting has been fine, but a temporary boost of chlorine is needed to adjust for heavy rain or a temporary bather load increase. Press and hold the  $\Delta$  or  $\nabla$  buttons simultaneously to activate the Boost feature and temporarily elevate the chlorine production level to 100% for 24 hrs. The chlorine output will revert to the original setting after 24 hrs. of pump run time.
3. The sanitizer output needs to be increased.
  - Use the  $\Delta$  button to increase the sanitizer output setting.
  - Increase the pump run time so the ChlorSync® is generating chlorine for a longer period of time. (Systems are typically sized for a minimum 8 hr. pump run time.)
4. Consult your local pool/spa service professional and test for high phosphate levels. Use a product such as Lo-Chlor® Lo-Phos® to reduce phosphates.
5. If the water temperature is 55°F (10°C) or colder, the ChlorSync® has automatically turned the sanitizer output down to 1% to avoid over-chlorination. Bacteria and algae activity is greatly reduced at these temperatures, so this should not be a problem. Hand dose additional chlorine if necessary.
6. Obtain an independent salt reading to check the ChlorSync® reading. Add salt if needed.
7. Consult your local pool/spa service professional and test for metals present in the pool/spa water.
8. Clogged or dirty cell. Inspect cell and clean as necessary.

#### Problem

There are no warning messages on the display. The chlorine level is too low, but the pool/spa water looks fine.

#### Typical Solution

The test kit reagents or strips may be old or have been exposed to sunlight. Replace the kit or reagents and retest.

There may be too much chlorine in the pool/spa. The chlorine is bleaching the test kit reagents.

- Dilute the water sample with distilled water and retest. Lower the chlorine output setting with the ▽ arrow button if the chlorine level is too high.

## **"Lo saLt" message is displayed / Salt LED is solid red**

### **Problem**

The salt level is between 2,300-2,700 ppm (mg/L), which is low.

### **Typical Solution**

This message will appear when salt is between 2,300 - 2,700 ppm (mg/L). Test the salt level using salt test strips or have water tested by your local pool/spa professional. Bring the salt level up to 3,500 ppm (mg/L).

When paired with the PoolSync™ option, consult the PoolSync™ app for more information.

## **"Add SaLt" message is displayed / Salt LED is flashing red**

### **Problem**

Chlorine generation has stopped because the salt level is below 2,300 ppm (mg/L), which is too low.

### **Typical Solution**

Test the salt ppm level using salt test strips or have water tested by your local pool/spa professional. Bring the salt level up to 3,500 ppm (mg/L).

When paired with the PoolSync™ option, consult the PoolSync™ app for more information.

## **Cell LED is flashing red. Display shows "CELL"**

### **Problem**

The cell is dirty or may have calcium build up.

### **Typical Solution**

Inspect and clean as appropriate. See "*Cleaning the Cell*" on page 17.

### **Problem**

Salt level may be low. Check the salt indicator LED and display for possible error messages.

### **Problem**

Pool/spa water chemistry may not be balanced. See "*Water Balance and Chemistry Recommendations*" on page 9.

### **Typical Solution**

Contact your local pool/spa professional and take necessary steps to balance the body of water.

Note: The cell LED may also flash red if salt has been added to the pool/spa water recently. Wait 24 hours for salt to be completely diluted.



## Flow LED is flashing red

### **Problem**

Insufficient water flow.

### **Typical Solution**

Confirm circulation pump is working correctly. If using a variable speed pump, confirm pump is set to appropriate RPM setting to achieve the minimum 20 gpm required at the cell.

Check pump strainer basket and clear debris.

Valves may be closed. Confirm all valves are aligned correctly.

Filter may be dirty. Check the pool/spa filter and clean as appropriate.

There may be an obstruction in the cell. Inspect and clean the ChlorSync® cell as appropriate.

See "*Cleaning the Cell*" on page 17.

### **Problem**

Possible flow switch failure.

### **Typical Solution**



Contact your local AutoPilot® service representative or AquaCal AutoPilot Customer Support.

## Display alternates between output percentage and a 24 hour countdown timer

### **Problem**

The cell is in "Boost" mode.

### **Typical Solution**

To turn the Boost mode off, press and hold both  and  buttons simultaneously.

## ChlorSync® unit does not have power

### **Typical Solution**

Check the fuse in the power center and replace as appropriate. See "*Electrical Installation*" on page 19.

### **Typical Solution**

Verify that the power center is receiving proper 110 VAC or 220 VAC power.

### **Problem**

Transformer leads not wired correctly in power center.

### **Typical Solution**

Confirm the transformer is wired correctly. See the wiring diagram on the inside cover of the power center.

## SPECIFICATIONS AND APPROVALS

### Agency Approvals

Tested to conform to the following specifications:

SPECIFICATION	DESCRIPTION
UL1081	Safety Standard for Swimming Pool Pumps, Filters and Chlorinators.
CAN / CSA-C22.2#218.2	Safety Standard for Spas, Hot Tubs, and Associated Equipment

### FCC Compliance

NOTE: This equipment has been tested and found to comply with the limits for a Class B digital device, pursuant to part 15 of the FCC Rules. These limits are designed to provide reasonable protection against harmful interference in a residential installation. This equipment generates uses and can radiate radio frequency energy and, if not installed and used in accordance with the instructions, may cause harmful interference to radio communications. However, there is no guarantee that interference will not occur in a particular installation. If this equipment does cause harmful interference to radio or television reception, which can be determined by turning the equipment off and on, the user is encouraged to try to correct the interference by one or more of the following measures:

- Reorient or relocate the receiving antenna.
- Increase the separation between the equipment and receiver.
- Connect the equipment into an outlet on a circuit different from that to which the receiver is connected.
- Consult the dealer or an experienced radio / TV technician for help.





[www.aquacal.com](http://www.aquacal.com)



[www.autopilot.com](http://www.autopilot.com)

AquaCal AutoPilot, Inc.  
2737 24<sup>th</sup> Street North  
St. Petersburg, Florida 33713  
(727) 823-5642