

<p>Imported to Canada by AquaCal AutoPilot, Inc.. 2737 24th ST North St Petersburg, FL 33713 USA Phone: 1.727.823.5642</p>
<p>REGISTRATION NO. 27844 Pest Control Products Act Lectranator Digital Model DIG48 Chlorine or Bromine Generating Device</p>
<p>One DIG48 unit can treat a maximum of 153,000 Liters of swimming pool water.</p>
<p>NOTICE TO USER: This pest control product is to be used only in accordance with the directions on the label. It is an offence under the Pest Control Product Act to use this product in a way that is inconsistent with the directions on the label. The user assumes the risk to persons or property that arises from any such use of this product.</p>
<p>For swimming pools, a minimum of 1 ppm of free available chlorine or bromine must be maintained. For spas, a minimum of 3 ppm of free available chlorine or bromine must be maintained.</p>
<p>Controls Bacteria and Algae in Swimming Pool Waters.</p>
<p>Maximum output of hypochlorous or Hypobrom equivalent to 0.82 kg of free available chlorine ous acid</p>
<p>WARNING: Operating the LECTRANATOR DIGITAL MODEL DIG48 without water flow through the cell can cause a build up of flammable gases which can result in FIRE OR EXPLOSION</p>
<p>DOMESTIC READ THE LABEL AND THE INSTALLATION AND OPERATION MANUAL BEFORE USING KEEP OUT OF REACH OF CHILDREN</p>

per day

Cell Model RC-7

This is a replacement cell for the chlorine or bromine generating devices Lectranator Soft Touch Model ST48 REGISTRATION NUMBER 27841, PEST CONTROL PRODUCTS ACT, and Lectranator Digital Model DIG 48 REGISTRATION NUMBER 27844, PEST CONTROL PRODUCTS ACT. This cell must only be used on these models of chlorine or bromine generating device.

Read the Label and the Installation and Operation Manual of the chlorine or bromine generating device Lectranator Soft Touch Model ST48 or Lectranator Digital Model DIG 48 before using.

AquaCal AutoPilot, Inc., 2737 24th St North, St Petersburg, FL 33713 USA

Phone: 1.727.823.5642

Lectranator Digital Model DIG 48

by AquaCal AutoPilot, Inc.

Domestic Chlorine or Bromine Generating Device

KEEP OUT OF REACH OF CHILDREN

Installation and Operation Manual

MODEL DIG48 REGISTRATION NUMBER 27844 PEST CONTROL PRODUCTS ACT

Maximum Output of Hypochlorous or Hypobromous Acid Equivalent To 0.82 kg Of Free Available Chlorine Per Day
One DIG48 Unit Can Treat a Maximum Of 153,000 Litres Of Swimming Pool Water
Controls Bacteria And Algae In Swimming Pool Waters

(For Indoor or Outdoor Use)

RETAIN MANUAL FOR FUTURE REFERENCE



NSF50

IMPORTANT

READ THE LABEL AND THIS MANUAL BEFORE INSTALLING & OPERATING

NOTICE TO USER: This pest control product is to be used only in accordance with the directions on the label. It is an offence under the Pest Control Product Act to use this product in a way that is inconsistent with the directions on the label. The user assumes the risk to persons or property that arises from any such use of this product.

AquaCal AutoPilot, Inc., 2737 24th St North, St Petersburg, FL 33713 USA

Phone: 1.727.823.5642

Lectranator Digital Model DIG 48

by AquaCal AutoPilot, Inc.

Record The Following Information

Installer: _____	Date of Installation: _____
Control Unit Model Number: DIG48 _____	Control Unit Serial Number: # _____
Cell Model: # RC-7 _____	Cell Serial Number: # _____

Customer Assistance...
HOTLINE: 1.727.823.5642

Visit Us On The Internet @
www.autopilot.com

Lectranator Digital Model DIG 48

by AquaCal AutoPilot, Inc

Section 1b – GENERAL PRODUCT INFORMATION

IMPORTANT SAFETY INSTRUCTIONS

READ AND FOLLOW ALL INSTRUCTIONS

INSTALLATION AND EQUIPMENT RELATED

Installation of Lectranator Digital Model DIG 48:

When installing and using your Lectranator Digital Model DIG 48 Control Box, basic safety precautions must always be followed, including the following:

1. Follow all aspects of the local and National Electrical Code(s) when installing your Control Box.
2. During installation, mount your Control Box to ensure the least amount of direct exposure to rain, garden sprinkler water, direct sunlight or any corrosive environment.
3. DANGER – Risk of electrical shock. Install Control Box at least 3 m (10 ft.) for 115VAC Units, from the inside wall of the pool or spa using non-metallic plumbing. 1.5 m (5 ft.) minimum distance for 230VAC Units.
4. All field-installed metal components such as rails, ladders, drains or similar hardware within 3 m (10 ft.) of the spa or hot tub shall be bonded to the equipment grounding bus with copper conductors not smaller than 8.4 mm² (No. 8 AWG) in the U.S.A. and 6.3mm² (No. 6 AWG) in Canada.
5. WARNING – Maintain water chemistry in accordance with manufacturer's instructions.
6. DANGER – To reduce the risk of injury, do not permit children to use this product unless they are closely supervised at all times. Children should not use spas, hot tubs or pools without permanent adult supervision.

Equipment Related

115/230VAC, 50/60 Hz Models (fixed wiring)

1. A wire connector is provided on your Lectranator Digital Model DIG 48 to connect a minimum 8.4 mm² (No. 8 AWG) in the U.S.A. and 6.3mm² (No.6 AWG) in Canada solid copper bonding conductor between this unit and any metal equipment, metal enclosures of electrical equipment, metal water pipe or conduit within 1.5 m (5 ft.) of the unit.
2. A bonding terminal is located inside your Lectranator Digital Model DIG 48. To reduce the risk of electrical shock, this terminal must be connected to the grounding means provided in the electrical supply panel with a continuous copper wire equivalent size to the circuit conductors supplying your Lectranator Digital Model DIG 48.
3. A disconnection device from the power source, with a contact separation of at least 3mm (0.12 in.) in all poles, must be incorporated in the fixed wiring for permanently wired units.
4. The input voltage to the Lectranator Digital Model DIG 48 must match the 115/230VAC jumper terminals on the Circuit board, marked "TRANSFORMER PRIMARY", shown on Page 4.

SAVE THESE INSTRUCTIONS

Table of Contents

Lectranator Digital Model DIG 48

by AquaCal AutoPilot, Inc.

Section 1 GENERAL INFORMATION

1a	Product Information and Contact Numbers.....	1
1b	Important Safety Instructions.....	2
1c	Table of Contents.....	3

Section 2 INSTALLATION

2a	Main Components	4
	Control Box Connections.....	5
	Electrical Connections	
	Cell Cord and Tri-Sensor Connections	
	Remote ORP Connections	
2b	Cell and Manifold Installation.....	6
	Verification of Flow Switch Protection	6

Section 3 OPERATION

3a	Key Features – Display Panel.....	7-9
3b	Pool Water Preparation	10
	Salt Requirement Chart	
	Start-Up Procedures	
3c	Monitoring and Maintenance.....	11
	Water Chemistry Parameters	
	Saturation Index	

Section 4 SERVICE and MAINTENANCE

4a	Control Box and Fuse Locations.....	12
	Tri-Sensor Assembly	12
4b	Cell	13
	Removal and Inspection	
	Maintenance and Cleaning	
	Filter Backwashing	13
4c	Parts Explosion.....	14

Section 5 TROUBLESHOOTING

5a	Troubleshooting.....	15
----	----------------------	----

Main Components

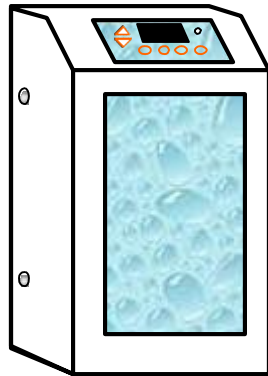

Control Box

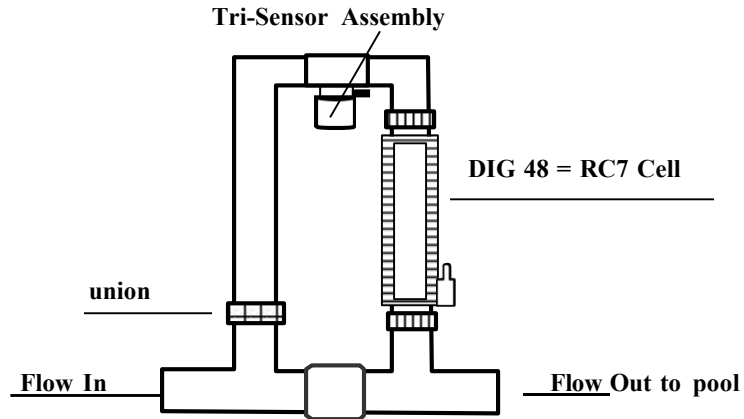

Flow Bypass Manifold Assembly

CONTROL BOX converts incoming AC power to a Low Voltage DC current, which energizes the Cell(s). Set the **Control Box** on a vertical surface away from excessive exposure to heat and moisture. Use the template to mark and drill the (4) mounting holes and insert the screws, leaving a ¼ in. gap. Hang the control box on the screws and level. Remove the cover by following the steps on page 12 to access the mounting holes to tighten the screws.

ELECTROLYTIC CELL receives Low Voltage DC current from the Power Circuit Board, which initiates the electrolytic process. This process converts ordinary table salt (Sodium Chloride) to 100% Pure Sodium Hypochlorite (Chlorine Bleach) or Bromine (with the addition of Sodium Bromide), which in turn sanitizes your pool or spa. See page 10 for salt requirements.

TRI-SENSOR ASSEMBLY ensures that adequate flow, 94.5 L/min. (25 US Gallons/min.) minimum; **salt**, 2.8 – 3.2 gm/l (2800–3200 ppm) ideal range; and **water temperatures**, above 15.6 °C (60°F) are satisfactory to prevent abusive conditions for the cell to operate. See page 12 for instructions to remove and inspect the tri-sensor assembly.

RATINGS:

Input Power: 115 VAC (3.0 AC amps)
chlorine/day 230 VAC (1.5 AC amps)
50/60 Hz

Maximum Output: Equivalent to 0.82 kg (1.80 lbs) of free available
RC-7 Cell@ Power Level 3 (8 amps DC)
Cell Life Expectancy: A minimum of 15,000 ampere/hours

Output Power: Cell Power 1 (5.0* DC amps) Agency Approvals: NSF, ETL us, ETL c, CE
Cell Power 2 (6.5* DC amps)
Cell Power 3 (8.0* DC amps) Internal Pump Relay is rated for 30-amp max.

*Indicates nominal amperage output. The dual axis controller will slightly vary the amps to optimize the power to the cell.

The cell and tri-sensor are located in a Flow Bypass Manifold Assembly. 3.6 m (12 ft.) of **Cell and Tri-Sensor cords** are provided with the unit. Ensure that the manifold is located within that distance from the control box with enough slack to allow for removal for service or maintenance.

The Digital display provides full information and diagnostic for maintenance and operation of your system. The programmable settings are retained on a microprocessor chip with the clock setting backed-up with a CR-2025 lithium battery.

CAUTION: It is suggested to locate the cell downstream of all other equipment and on the pool return line only to avoid over-saturation conditions of your spa. For applications other than as recommended, contact the factory.

Section 2b – INSTALLATION

Control Box Connections

Electrical Connections

Autopilot recommends that a licensed electrician or certified electrical contractor perform the electrical connections.

DANGER: ensure that the electrical panel or filter pump circuit breaker is turned OFF before wiring this unit.

Your Lectranator Digital Model DIG 48 Control Box comes pre-wired from the factory for 230VAC (1.5 amps max draw) and can also operate on 115 VAC, (3.0 amps max draw) at 50/60Hz. 1.8 m (6 ft.) of AC lead wires are provided with the unit and are located on the bottom base plate of the control box along with the Cell, Tri-Sensor and optional ORP Interface connections.

Converting to 115VAC is accomplished by accessing the circuit board, rewiring, and attaching the included jumper as shown below. Remove the cover (see page 12) to access and ensure that the Jumper Connections on the circuit board marked “TRANSFORMER PRIMARY” are matched to the LINE IN voltage. Follow all state/local codes for electrical installations.

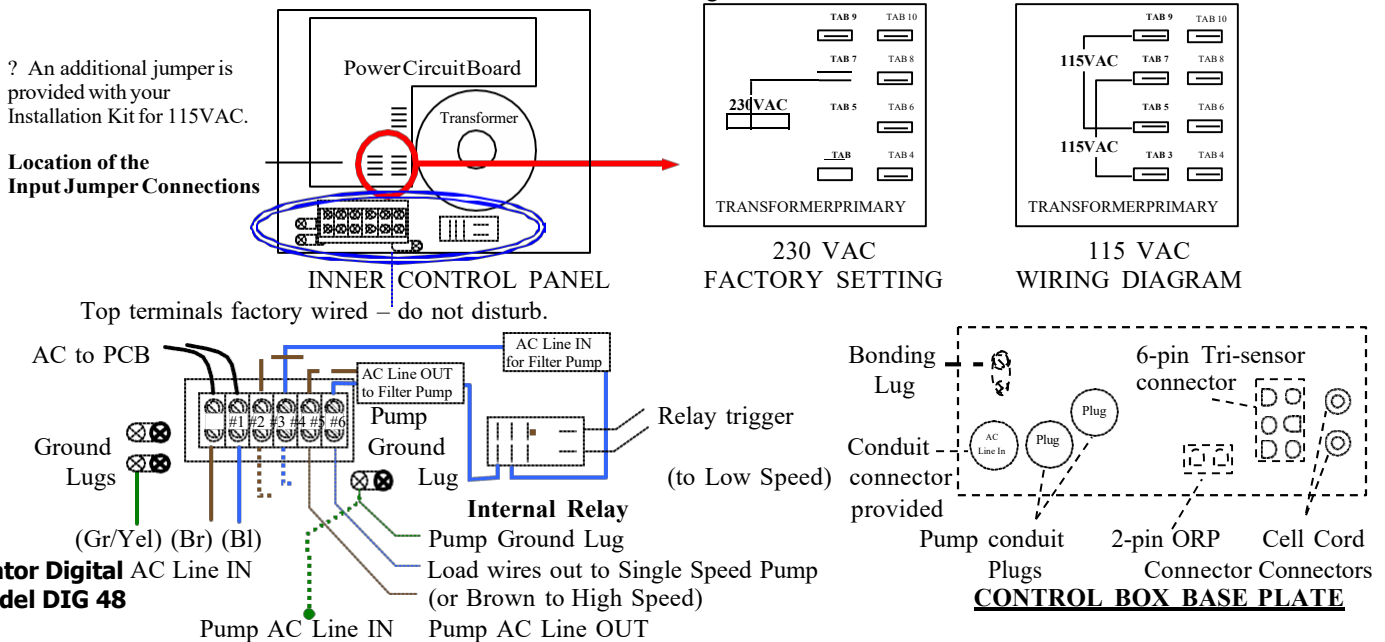

AC LINE IN (Wiring diagram also located on inside of cover):

For 230 VAC; Brown (Br) = Line 1, Blue (Bl) = Line 2, Green w/Yellow Tracer (Gr/Yel) = Earth Ground

For 115 VAC; Brown (Br) = Line, Blue (Bl) = Neutral, Green w/Yellow tracer (Gr/Yel) = Earth Ground

The AC Line IN wiring is pre-set for connection to the **LOAD SIDE** of your time clock, electronic controller switch or relay to work in conjunction with your circulation pump.

For control of your main circulation pump (single or two speed) through the Lectranator Digital Model DIG 48's Internal Relay, cut and strip the pre-wired Line In wires, and jump #1 to #3 and #2 to #4 (Gr/Yel can be discarded). Route a new set of Pump AC Line IN wires from the circuit breaker/electrical panel into #3, #4 and Pump Ground Lug. Connect Pump AC Line OUT to #5, #6 and Pump Ground Lug. This relay is rated for 30-amp max. Ensure that the Line In and Line Out wire sizes are according to electrical guidelines. Follow the menu program, pages 8 & 9, to program the *Digital* to your particular application. Ensure that the Lectranator Digital Model DIG 48 Control Box is properly bonded to a grounding circuit.

Cell Cord. Each Cell Cord contains (2) Banana Plugs that attach to the (2) Banana Jacks on the bottom of the Control Box.

Polarity does not matter. The other end of the cell cord has a three-position plug that connects to the cell in any direction. See page 13 for service instructions.

Tri-Sensor Cord. The Tri-Sensor Cord connects to the keyed 6-pin harness on the Control Box Base Plate. The opposite end of the cord connects to the Tri-Sensor Assembly with a locking ring quick connect. Align the groove and keyway on the connector and twist the locking ring to ensure a proper connection. Refer to the instructions on pages 12 & 14 for diagrams and additional instructions.

ORP Connection. When an ORP Chemical Controller is interfaced to your Lectranator Digital Model DIG 48, the Chemical Controller will remotely control the sanitizer Output. Adjust the output level to 0% and connect the ORP controller to the 2-pin connector on the Control Box Base Plate. When the ORP is activated, the output will indicate ON with the display showing 0%.

WARNING: THE ORP CONNECTIONS ARE DRY CONTACT INPUTS, DO NOT ENERGIZE THESE INPUTS! DAMAGE TO THE CONTROL BOX WILL OCCUR AND WILL VOID THE WARRANTY.

Cell and Manifold Installation

Your Lectranator System is adaptable for use with the 7 blade (RC-7) cell. The manifold must be located as the last accessory in the **POOL RETURN LINE** only. For special plumbing configurations, please contact your representative for assistance in locating the manifold.

Standard Manifold Assembly:

Bypass flow rate should be set at 94.5 L/min. (25 US Gallons/min.).

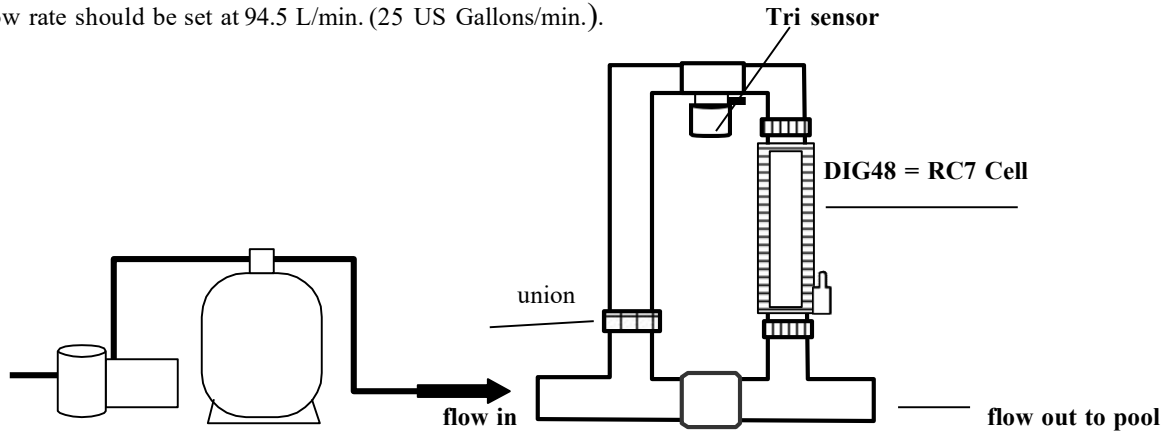

For other plumbing configurations, please contact your representative for assistance.

Verification of Flow Switch Protection:

It is important to **ANNUALLY** inspect and verify the safe and proper operation of the Tri-sensor's Flow Switch protection device. We recommend following this procedure to verify that the flow switch is working as designed, which is to halt power from being sent to the cell in the presence of insufficient flow. A defective Flow Switch could cause serious personal and/or equipment damage. Using either a GOLF BALL or small plastic wrap (saran wrap, food wrap or zip lock bag), block off flow to the upper portion of the manifold by placing the golf ball in the strainer screen union or by wrapping the strainer screen with the plastic wrap and placing it back in the union and tightening. Operating the system on with this blockage should detect a FLOW obstruction, indicated on the digital display and activating a red flashing CHECK SYSTEM light. Once this protection feature has been verified, remove the plastic wrap or golf ball, replace the strainer screen and resume operation. Turn the output dial to OFF and contact the factory if the flow switch protection is not working properly.

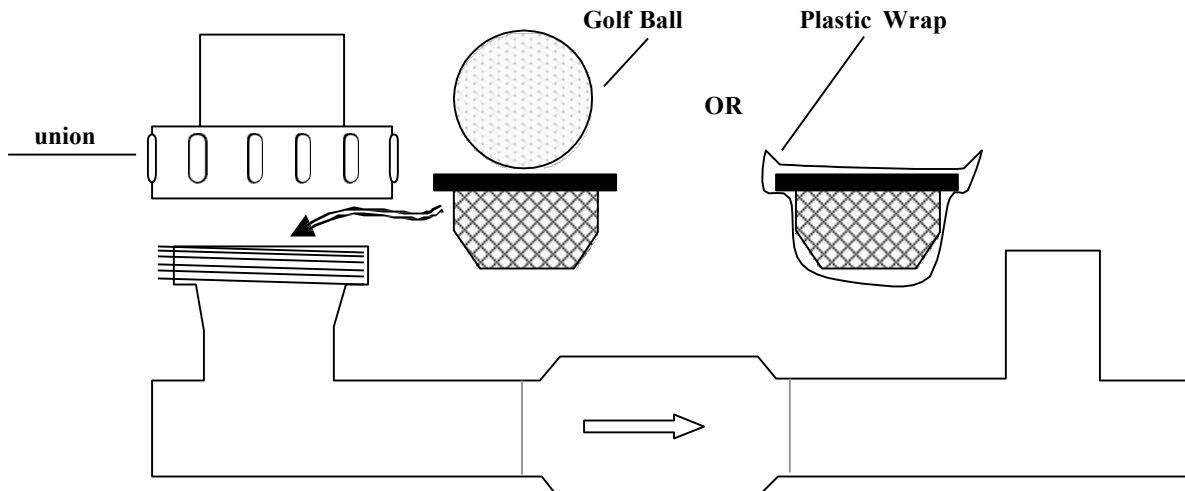

Section 3a – OPERATION

Key Features

The Lectranator Digital Model DIG 48 display will show the **SANITIZER OUTPUT LEVEL** (in percent %) and whether the system is in **BOOST** or **SUPER-BOOST Mode** on the first line of the two line alphanumeric display. The second line will display the current **TIME** in either 12 or 24-hr mode, the **TEMPERATURE** in either Fahrenheit or Celsius, whether the cell is powered or not, shown as ON or OFF and **Polarity Direction**, shown as a “.” or blank. Easy touch pads allow for adjusting and programming the unit. A **Check System** visual alarm indicator works in conjunction with the display to advise of any problems. All Menu, Select and Pump functions as well as any “Error messages” will be displayed on both lines of the alphanumeric display.

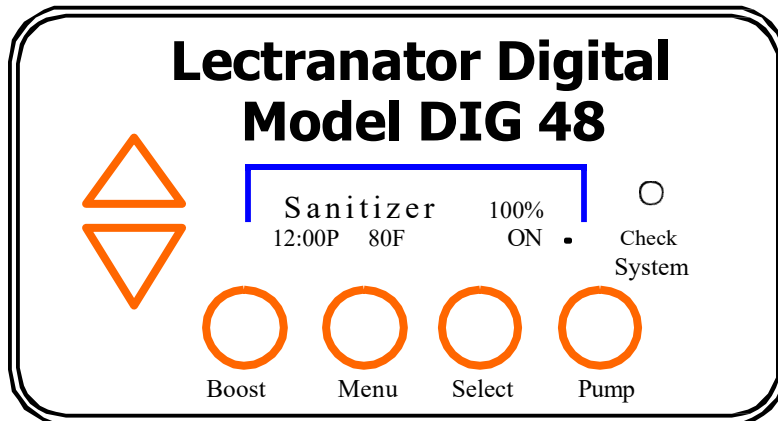

The **SANITIZING OUTPUT LEVEL** is adjustable from 0% (OFF) to 100 % (MAX) by pressing the **Up/Down** Arrows to obtain the desired Sanitizer Output Level. Little adjustment is needed once the initial setting is established.

Note: The Lectranator Digital Model DIG 48 does not test for sanitizer levels nor automatically adjust to maintain a desired sanitizer level. This is done by periodically testing the water and adjusting the output levels up or down, as needed.

The Lectranator Digital Model DIG 48 is designed with an **AUTOMATIC TEMPERATURE COMPENSATION** feature , which automatically adjusts the output level setting based upon changes in seasonal water temperatures only. This unique feature conveniently compensates for warm (more sanitizer needed) or cold (less sanitizer needed) water conditions.

The **BOOST Button** increases the sanitizer output level to 100% for up to 72 hours, regardless of the initial output level setting. The sanitizing agent is produced, continually; throughout the normal On/Off cycles of the pump and throughout all power line disturbances until the end of the cycle or when manually discontinued. When Boost is activated with **External Timer** setting programmed, the time remaining for the boost cycle is held in memory and will start up in Boost mode until expired. With **Pump Program** or **2-Speed Pump** setting programmed, the time clock will be overridden, producing sanitizer until the end of the boost cycle. The display will indicate the **BOOST Mode** on the second line when the boost Button is pressed once. Once activated, the system will produce the sanitizing agent for 24 hours. The sanitizing agent can be produced for 72 hours by pressing and holding down the Boost Button for 5-seconds from the Boost-Off position. This is called the **SUPERBOOST Mode** . The display will indicate that the system has successfully entered the Super Boost mode. To discontinue operation of Boost mode or Super Boost mode, pressed the Boost Button once more. The pool/spa pump must be turned on during the whole boost cycle. Do not let the pump run on a timer during that period.

The **Menu** and **Select Buttons** allows you to view the TEST mode, program the functions and time clocks. See the following pages for description of the menu tree.

* The **PUMP Button** allows you to override the pump timer to temporarily turn the pump on or off (depending on its status of operation), or to manually turn the pump off, indicated by the display “OFF FOR MAINTENANCE”. In “OFF FOR MAINTENANCE” mode, the pump is prevented from restarting by the time clock and is only reactivated only by manually programming it to turn the pump back on. Not applicable with “EXTERNAL TIMER” selection.

The **CHECK SYSTEM** light will flash if there is a problem with the system. The nature of the problem will be indicated by the display through various error messages. See the Troubleshooting section, page 14, for repair solution.

FREEZE PROTECTION: this protective feature allows the pump, when programmed for One-Speed Pump, to override the program cycle and run continually (30-minute minimum) when the water temperature falls below 4.4°C (40°F). This prevents any damage to the PVC due to water expanding as it freezes.

Key Features – continued

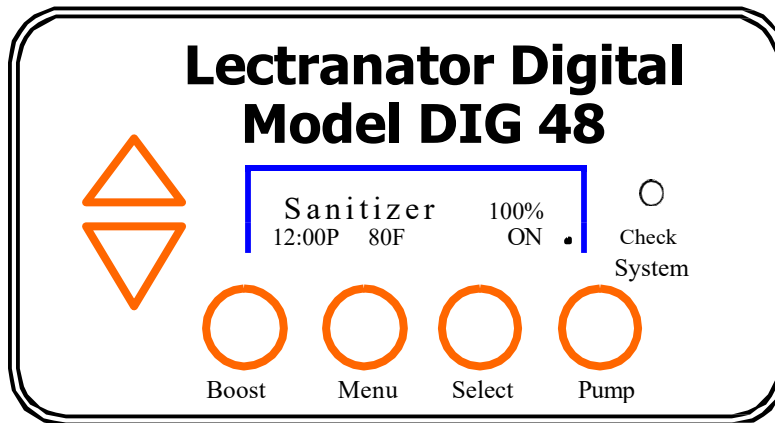

The **MENU Button** allows you to enter the programming and monitoring functions.
Use **UP/DOWN ARROW** and **SELECT** to scroll through the Main menu and Sub-menu:

Main Menu

- 1.0 Test Lectranator Digital Model DIG 48
- 2.0 Owner Options
- 3.0 Maintenance Menu
- 4.0 Installer Menu
- 5.0 Exit Menu Mode

SUB-MENUS

1.1 TEST Lectranator Digital Model DIG 48

The display will automatically cycle through this program, then return to normal operation. The display shows as follows:

- 1.2 **Salt** in grams per liter (gm/l) or parts per million (PPM)
- 1.3 **Add Salt** indicates the amount of salt needed to add to establish 3.0 gm/l (3000 ppm) based upon pool volume
- 1.4 **Temperature** in Celsius or Fahrenheit.
- 1.5 **Cell Volts and Amps**

2.1

OWNER OPTIONS

Use **UP/DOWN ARROW** and **SELECT** to scroll through the sub-menu. After completing a step, it displays the next step:

- 2.2 **English/Metric**: displays volume in gallons or cubic meters; salt additions in lbs or kg; **Back – Main Menu** (2.0)
- 2.3 **Temperature Units**: displays the water temperature in **Fahrenheit** or **Celsius**; **Back - Main Menu** (2.0)
- 2.4 **12/24-hour Time**: displays the current time in **12-hour Time** or **24-hour Time** units; **Back – Main Menu** (2.0)
- 2.5 **Set Time of Day**: sets the time as follows: **Set Hours**; **Set Minutes**
- 2.6 ***Pump Program 1**: allows you to program the pump on/off cycle through the on-board program
- 2.7 ***Pump Program 2**: allows you to program a secondary pump on/off cycle through the on-board program
- * Only applicable with **Pump Config.** (4.6) selection of **One-Speed Pump** or **Two-Speed Pump**
- * Pump Program 1 or 2 will show the previous time set. Otherwise, **Not Programmed** will display, then automatically step to display **▲-Prog. ▼-Delete SELECT-No Change**
Selecting **▲-Prog** steps to **Pump ON at Set Hours “12”:00 P; Pump ON at Set Mins 12:“00” P**
then **Pump OFF at Set Hours “12”:00 P; Pump OFF at Set Mins 12:“00” P**
- 2.8 **Back – Main Menu** (returns to MAIN MENU)

Key Features – continued

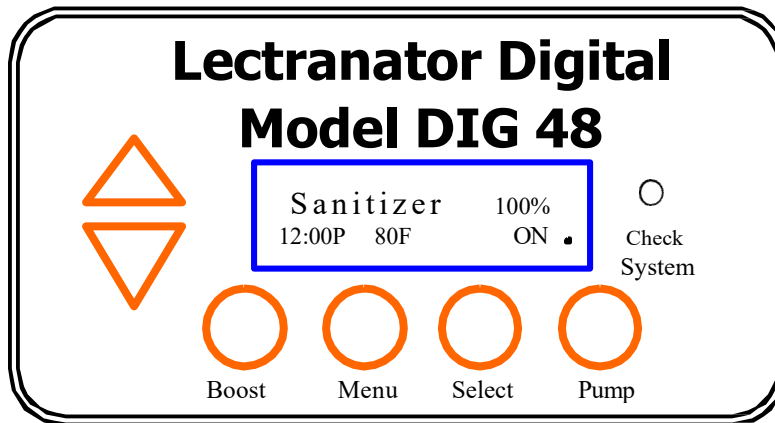

Use **UP/DOWN ARROW** and **SELECT** to scroll through the sub-menu. After completing a step, it displays the next step:

- 3.1 **Test:** same as 1.0 above plus cell **Amp-hrs** – then returns to Main Menu (3.0)
- 3.2-3.4 **Set Time of Day:** same as 2.4 above
- 3.5 **Force Reverse:** allows you to check cell volts and amps in the opposite direction (verifies reversing feature)
- 3.6 **Set Reverse Time :** allows adjustable self-cleaning reverse rate of **2, 4, 8** or **16** hrs; **Back – Main Menu** (3.0)
Cell reversal is set on 4-hrs from the factory for ideal cell life. For conditions such as high calcium levels that can cause the cell to scale quicker than the self-cleaning cycle can control, change the setting to “2” hours.
For vinyl liner pools or optimum water chemistry balance according to the Saturation Index, see page 10, changing the REVERSING cycle to “8” or “16” hours will extend the life of the cell.
If the Reverse Time is set to the “16” hours setting, check the cell weekly for the first month to ensure no scale develops. If there is scale development, change the setting to “8” hours.
- Note:** changing the Reversing Time to “2” hours will affect the cell life. However, operating with scale development on the cell is more damaging to the life of the cell and changing the reversing time is suggested
- 3.7 **Calibrate Salt:** allows you to calibrate the salt display. Contact the factory for calibration solution
- 3.8 **Replace Cell:** Only used when replacing cells. May be used to zero the amp -hour counter. Consult Lectranator Systems Inc. for details
- 3.9 **Back – Main Menu** (returns to MAIN MENU)

4.1

INSTALLER MENU

(Hold **Select** for 10 seconds to enter this mode)

Use **UP/DOWN ARROW** and **SELECT** to scroll through the sub-menu. After completing a step, it displays the next step:

- 4.2 **English/Metric:** displays volume in gallons or cubic meters; salt additions as lbs or kg; **Back – Main Menu** (4.0)
- 4.3 **Temperature Units:** displays the water temperature in **Fahrenheit** or **Celsius** ; **Back - Main Menu** (4.0)
- 4.4 **12/24-hour Time :** displays the current time in **12-hour Time** or **24-hour Time** units; **Back – Main Menu** (4.0)
- 4.5 **Set Pool Volume :** displays the volume of the pool in either **Gallons** or **Cubic Meters**
- 4.6 **Set Cell Power:** allows you to set the **Power Level = 1, 2** or **3**. **Warning: Operating on “1” reduces cell power but extends cell life, “3” increases cell power but reduces cell life.** **Back – Main Menu** (4.0)
- 4.7 **Set Pump Config:** allows you to select from **External Timer, One-Speed Pump** or **Two-Speed Pump** configuration
- 4.7- 4.9 **Set Time of Day:** same as 2.4 – 2.6 above
- 4.10 **Back – Main Menu** (returns to MAIN MENU)

Error Messages:

If the message “**Sanitizer Off**” is shown, the system halts sanitizer production. This is shown when the unit is at rest or when the salt level is extremely low.

If the message “**Warning!**” is shown, the system will continue to produce sanitizer but at a reduced efficiency. This is associated with a warning message to check the system.

Section 3b – OPERATION

Pool Water Preparation

Salt Requirements

It is important that with typical pools, a salt residual of 2.8 – 3.2 gm/l (2800 to 3200 ppm) be maintained at all times for peak efficiency.

NOTE: Maintaining high salt levels above recommended range can contribute to corrosion of pool/spa equipment. Salt levels exceeding the recommended concentration can be reduced by diluting the pool/spa with fresh water.

The amount of salt required depends on the size of the pool and the present salt level. Broadcast the salt around the perimeter of the pool. DO NOT add salt directly into any skimmer or gutter device. As the salt is being added, we recommend running the circulation pump continually for 24 hours with the main drain opened. Brushing the salt towards the bottom main drain will assist in the dissolve rate and prevent possible staining with certain types of salt.

We recommend the use of **TABEX LectraClor™ or LectraClor Plus™** blended salt products. These products do not contain Yellow Prussiate of Soda (YPS) or Iodine which could cause a localized tint to the water or brown staining on the cementitious finish if allowed to rest undissolved on the finish for extended periods of time. **LectraClor Plus™** is blended with the proper amount of stabilizer to maintain a proper level within the recommended range when added according to the salt chart on the box.

Granular Salt, Table Salt, Solar Salt or Water Conditioner Pellets can also be used but will have different dissolve rates. If the salt you use contains Iodine or YPS, constant brushing may help the dissolve rate and minimize staining due to the additives in the salt. Ensure that ANY salt you use contains a minimum purity of 99% Sodium Chloride (NaCl).

NOTE: Do not use Rock Salt due to its high levels of impurities.

TEST YOUR WATER FOR SALT LEVEL FIRST with the provided salt test strips, and then use the chart below to determine the amount of salt to add.

SALT REQUIREMENT CHART

KILOS (LBS.) OF SALT NEEDED FOR 3000 PPM RESIDUAL								
SALT Level Before Addition	Pool Volume in Liters (US Gallons)							
	3,780 (1,000)	9,430 (2,500)	18,900 (5,000)	28,300 (7,000)	37,780 (10,000)	56,700 (15,000)	75,600 (20,000)	113,600 (30,000)
0 ppm	11.3 (25)	28 (63)	57 (126)	85 (175)	113 (252)	175 (378)	227 (504)	340 (756)
500 ppm	9.5 (21)	24 (53)	48 (106)	73 (147)	95 (212)	145 (318)	191 (424)	286 (636)
750 ppm	8.6 (19)	22 (48)	43 (96)	66 (133)	86 (192)	130 (288)	173 (384)	259 (576)
1000 ppm	7.7 (17)	19 (43)	39 (86)	54 (119)	77 (172)	116 (258)	155 (344)	232 (516)
1500 ppm	5.9 (13)	15 (33)	30 (66)	41 (91)	59 (132)	89 (198)	119 (264)	178 (396)
2000 ppm	3.6 (8)	9.5 (21)	19 (42)	30 (56)	38 (84)	57 (126)	76 (168)	113 (252)
2250 ppm	2.7 (6)	7 (15)	14 (30)	19 (42)	28 (60)	41 (90)	54 (120)	81 (180)

Note: The above chart is based on 120 grams of salt added to 1000 Liters of water (1 lb. per 1,000 gallons) to increase your salt residual 120-ppm.

Start Up Procedures

Keep the Output Setting on your Lectranator Digital Model DIG 48 on 0% (OFF) until you get your water clear, blue and properly balanced

1. After balancing your water chemistry according to the Water Chemistry Parameters shown on page 10, add the proper amount of salt (see Salt Requirement Chart above) and circulate 24-hours prior to starting your Lectranator Digital Model DIG 48.
2. The following day set your Output Level to 50% and operate normally. Test water as required to conform with local health code. Raise or lower output control setting as needed.
3. Once your Output Level has been established, you will only need to adjust your level according to increased bather usage.

Section 3c – OPERATION

Monitoring and Maintenance

Water Chemistry Parameters - VERY IMPORTANT NOTE! Your Lectranator Digital Model DIG 48 is designed to provide Sanitizer on a daily basis. We recommend the following water chemistry ranges and periodic checks to monitor your systems efficiency. Always follow local health requirements. Check the expiry date of the test kit as test results may be inaccurate if used after that date.

Daily Checks:		Monthly Checks:			
Free Chlorine:	1.0 – 3.0 PPM(pool)	Calcium Hardness:	200 -300 PPM (Pool) 150-200(spa) Salt Residual:	2800 – 3200 PPM	
Or Bromine:	1.0 – 3.0 PPM(pool)	Total Alkalinity:	100-120 PPM (Pool & Spa)	Saturation Index:	± 0.3 pH of saturation
Free Chlorine:	3.0 – 5.0 PPM(spa)	Cyanuric Acid:	30 – 100 PPM (Pool & Spa)	Visual Cell Inspection	for wear, scale or debris
Or Bromine:	3.0 – 5.0 PPM(spa)				
pH:	7.2 – 7.8				

CHLORINE/BROMINE REQUIREMENTS: During Peak Sanitizer Demand (rainy season or heavy bather usage) it may be necessary to increase your sanitizer level by increasing your Output Level setting and/or pump run time. Conversely, during Low Sanitizer Demand, you can decrease your Output Level to a lower setting. For extremely Heavy Sanitizer Demand or to boost your sanitizer levels quickly, you can **Boost** the system or supplement with a Potassium Monopersulfate based shock.

NOTE: During cold-water conditions, below 15.6°C (60°F) , Sanitizer demand is reduced significantly. For colder climate regions with freezing temperatures, contact your local pool professional for proper pool winterizing instructions.

CAUTION: Excessive chlorine levels can cause corrosion damage to stainless steel rails, ladders, heater heat exchangers, light faceplates and other metallic equipment. Avoid over saturation of chlorine levels. The output setting must be sufficiently high to maintain the recommended chlorine residual in the swimming pool/spa water. Provincial and/or municipal regulation must be followed.

pH: When your pH falls below the accepted range, your Sanitizer is used up very quickly and can be damaging to your equipment. For pH levels higher than the accepted range, your Sanitizer becomes much less effective and will work harder to keep your pool sanitized. Improper pH also contributes to the strong smell, red eyes, dry itchy skin and brittle hair conditions usually associated with “too much Chlorine”.

CALCIUM HARDNESS AND TOTAL ALKALINITY: Your Lectranator Digital Model DIG 48 provides 100% pure sodium hypochlorite and does not affect the calcium hardness or total alkalinity levels. Maintain and balance only as needed.

CYANURIC ACID (STABILIZER/CONDITIONER): This chemical goes by either trade name and allows your chlorine residual to last longer by protecting it from the UV degradation of the sun. In outdoor pools/spas with low or no Cyanuric acid, the chlorine being produced will be used up as quickly as it enters the pool. Check and maintain your cyanuric acid levels at the same time as your salt level, as these tend to deplete at the same rate. Regulations may exist regarding the use of cyanuric acid; please consult your local authority. **NOTE: For Bromine or indoor pools, it is not necessary to add stabilizer.**

SALT RESIDUAL: Your Lectranator Digital Model DIG 48 works most efficiently with salt levels between 2.8 – 3.2 gm/l (2800- 3200 ppm). If it falls below 2.8 gm/l (2800 ppm), determine the salt level and adjust according to the SALT REQUIREMENT. Low salt will cause premature deterioration of the Cell blades. Maintaining high salt levels above recommended range can contribute to corrosion of pool/spa equipment. Salt levels exceeding the recommended concentration can be reduced by diluting the pool/spa with fresh water.

BROMINE RESIDUAL: Along with the normal Salt level, add 0.45 kg (1 lb) Sodium Bromide (NaBr) per 7500 L (2000 gallons) of water. Your Lectranator Digital Model DIG 48 will now generate Bromine to sanitize your pool. Maintain your bromine level by checking your salt level. Once your salt falls below the recommended range, we suggest you add 0.45 kg (1 lb) sodium bromide with every 22.5 kg (50 lbs) of salt added. **NOTE:** Always use a registered or scheduled source of sodium bromide .

SATURATION INDEX (Si): a formula used to ensure that your total water chemistry does not fall into a scale forming or corrosive condition. Either condition can cause premature damage to the Cell, equipment and exposed pool/spa surfaces. Have your water professionally tested periodically according to the Saturation Index or use this chart to determine your water balance.

$$Si = pH + TF + CF + AF - Constant$$

Temperature	TF	Calcium Hardness	CF	ty	AF	TDS	Constant
15.6C 60F	0.4	150	1.8	75			
18.9C 66F	0.5	200	1.9	100			
24.4C 76F	0.6	250	2.0	125			
28.9C 84F	0.7	300	2.1	150			
34.4C 94F	0.8	400	2.2	200			
39.4C 103F	0.9	600	2.4	250			

Test your water for pH, Calcium Hardness, Total Alkalinity and TDS levels. Use the equivalent Factor in the Si equation.

Si = ±0.3, balanced Si above + 0.3, scaling, staining or cloudy water conditions.

Si below -0.3, corrosive to metals, etches/deteriorates plaster finishes or skin irritating conditions.

DO NOT add pool/spa chemicals directly to the skimmer. This may damage the cell.

Section 3c OPERATION (cont'd)

Additional notes:

- For proper sanitation, spa must be completely drained periodically. The number of days between COMPLETE SPA DRAINAGE is equal to the volume of spa water in liters, divided by 10 times the maximum number of daily spa users.
- Maximum spa usage temperature is 40°C (104°F). Duration in spa water at 40°C should not exceed 15 minutes.
- Heavy use of the spa (excessive contamination) may require longer recovery times (A return to a minimum of 3 ppm chlorine/bromine). Recovery time may be reduced by adding a shock compound to the water.
- Hot weather, heavy pool usage, and rain may require a higher output to maintain proper sanitizer residual.

Section 4a –SERVICE and MAINTENANCE

CONTROL BOX

There are very few serviceable parts on the Lectranator Digital Model DIG 48 Control Box except the fuses. For any other problems with the Control Box, please contact your representative or Authorized Dealer/Service Center.

To remove the Control Box Cover and access the fuses, follow these steps.

DANGER: TURN OFF THE AC POWER FROM THE CIRCUIT BREAKER OR PANEL BEFORE SERVICING THIS UNIT.

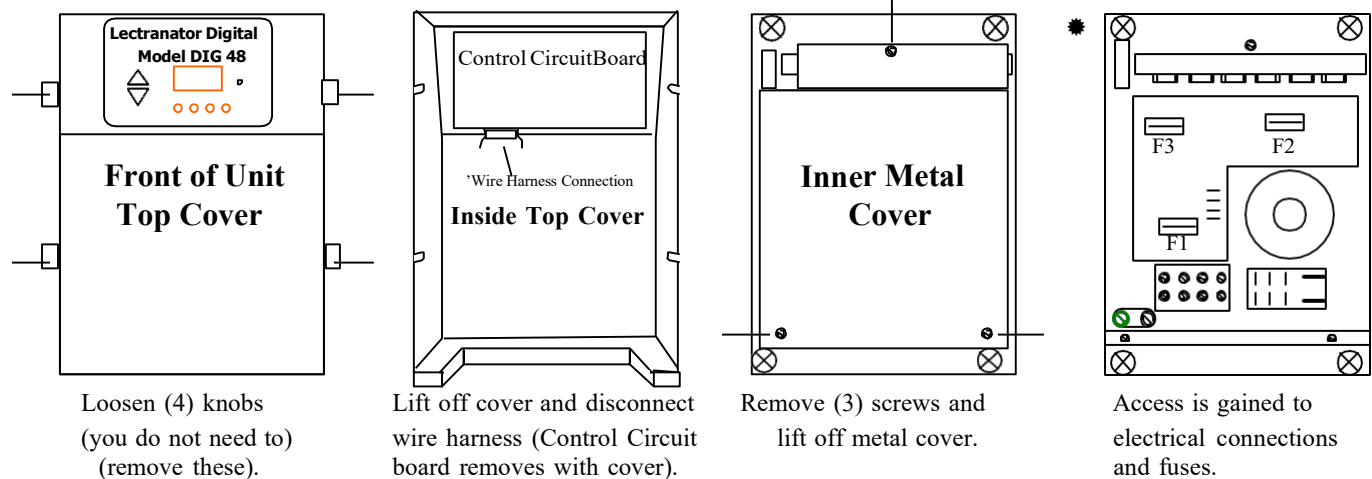

Fuse Location and Ratings

F1	Main AC Power Fuse	6 Amps 250 VAC
F2	Control Panel Circuit Board Fuse	3 Amps 250 VAC
F3	Cell Fuse	10 Amps 250 VAC

TRI-SENSOR ASSEMBLY

The Tri-sensor assembly tests for Flow, Salt and Water temperatures. A minimum flow rate of 94.5 L/min. (25 US Gallons/min.) is required to activate the flow switch. As the water flow closes the paddle, a magnet activates a micro switch to verify proper flow. The Salt sensor protects against low salt levels and the temperature sensor protects against cold water temperatures. Both of which can contribute to accelerated cell failure.

Remove the Tri-Sensor as follows (with pump off):

Remove both screws from the side of the Tee Assembly. Firmly grip the Tri-Sensor assembly and twist to loosen the compression o-ring.

With the aid of large Channel-lok® (or similar) pliers, twist back and forth while removing the Tri-Sensor from the tee. Inspect the thin metallic paddle for erosion and straightness. Take care not to twist or tweek this paddle, which can cause inaccurate flow readings. Inspect the salt sensor blades for scale and debris and clean if necessary. See page 12 for cleaning instructions. Follow the directions for Manual Cell Cleaning. Check the tri-sensor assembly for any damage to the plastic housing and replace if needed.

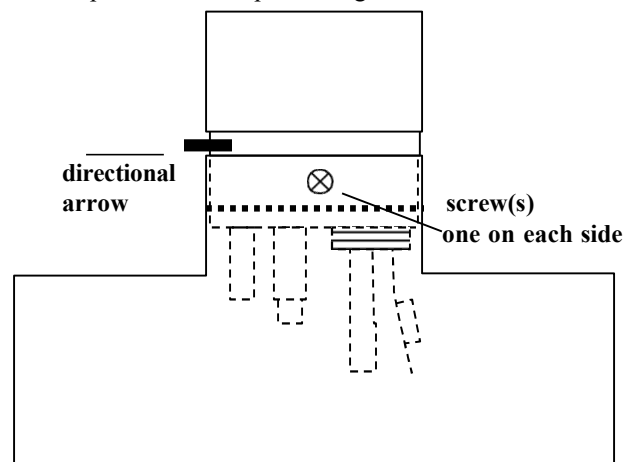

Section 4b –SERVICE and MAINTENANCE

Cell

The Cell is installed with Unions on each end of the cell to allow quick and easy removal. Loosen the unions and remove the cell from the plumbing.

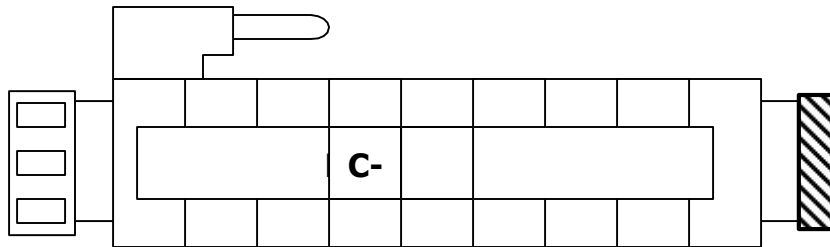

Side View of Cell and Unions

VISUAL CELL INSPECTION:

The titanium Cell blades, seen inside the Cell body, should be straight and clear of any debris between the blades. Your Lectranator Digital Model DIG 48 is designed to automatically self-clean scale build-up within the Cell. However, imbalanced water chemistry and certain conditions can cause a heavier scale build-up that exceeds the self-cleaning capability and would need to be cleaned manually by the method described below.

Periodically inspect both ends of the cell. A White Flaky or Crusty build-up on the edge or between the blades will prematurely deplete the life of the cell. Immediately clean the cell and determine the cause of scaling. See Troubleshooting Section, page 14.

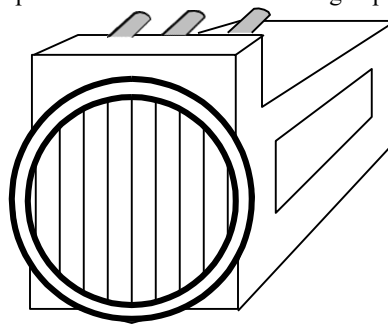

End View of cell
Looking at the Titanium Blades

MANUAL CELL CLEANING:

With the Cell removed as described above, use a high-pressure hose nozzle to spray off as much loose, soft scale and debris as possible. Any remaining calcium scale can be treated with a mixture of one (1) part Muriatic Acid into four (4) parts water. Mix the solution in a container high enough to cover the Cell blades. You may also use **TABEX LectraClean™** (non-fuming/pre-mixed) cell cleaner, per label directions.

Remove the Cell cord and immerse the Cell so that the blades are completely covered in the solution for up to 15 minutes. An effervescences action indicates the calcium is being neutralized and cleaned. Drain the cell, flush with fresh water and re-inspect. Repeat the immersion if necessary. Once the cell has been cleaned and rinsed; it may be re-installed in-line. **BE SURE THAT THE CELL "PINS" ARE CLEAN AND DRY BEFORE ATTACHING THE DC CORD FROM THE POWER SUPPLY. WARNING: ALWAYS ADD ACID TO WATER, never water to acid.**

When replacing the cell, only use replacement cells having a label that clearly states that it is a replacement cell for the chlorine or bromine generating device Lectranator Digital Model DIG48, REGISTRATION NUMBER 27844, PEST CONTROL PRODUCTS ACT.

NEVER USE ANY SHARP OR METALLIC OBJECTS TO REMOVE SCALE. Scraping or scratching the titanium blade's edge or surface will allow chemical attack of the blade, cause premature failure of the Cell and will void your warranty.

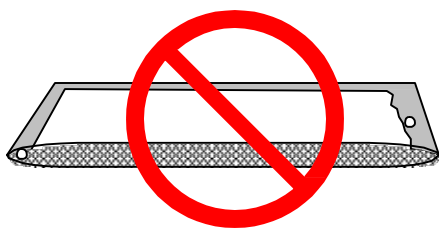

Hacksaw Blades

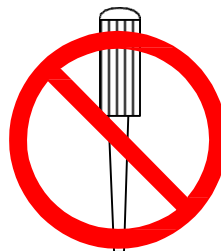

Screwdrivers

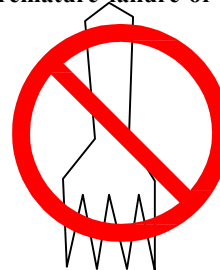

Forks

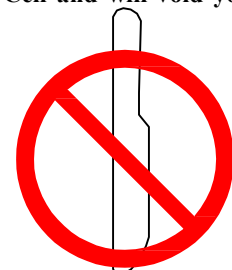

Knives

FILTER BACKWASHING:

NOTE: The Control Panel Output setting must be set to 0% (OFF) when backwashing the filter.

Parts Explosion

Manifold Assembly:

(#941)

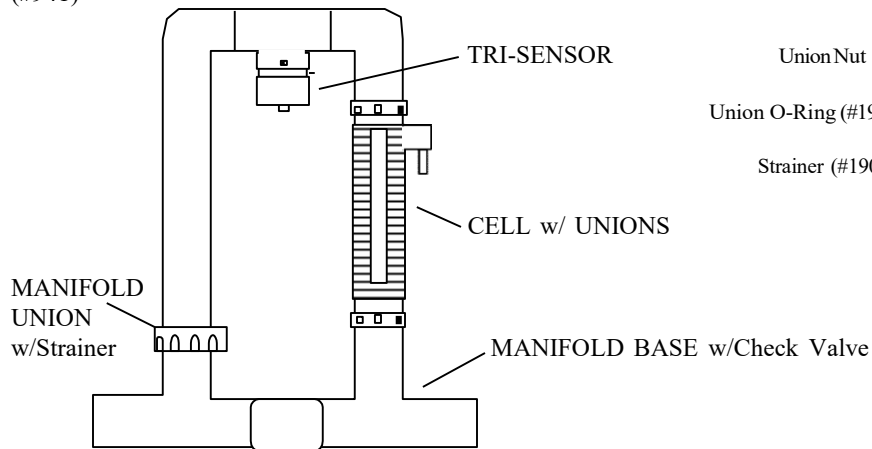

Manifold Union w/Strainer:

(#19065)

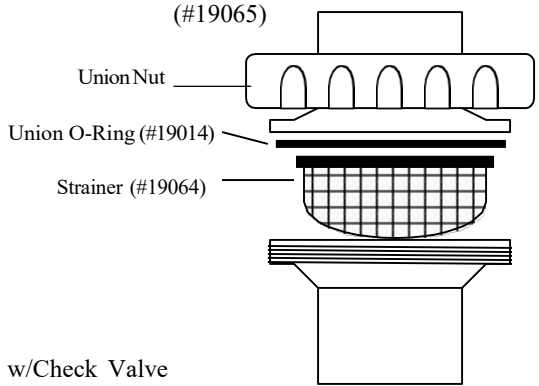

Electrolytic Cell:

(Cell Unions and Cord ordered separately)

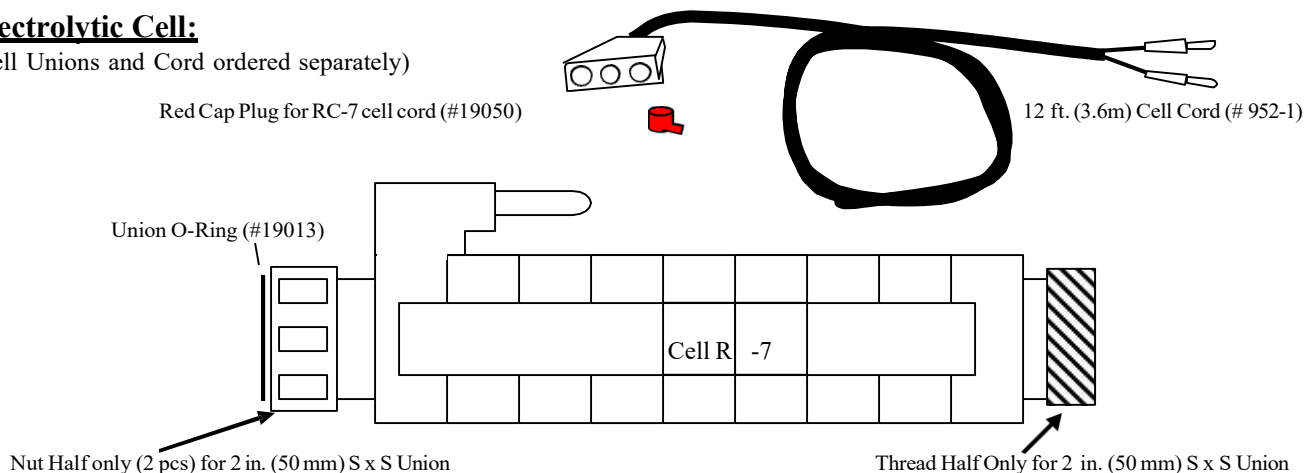

Tri-Sensor Assembly:

(Cord Ordered Separately)

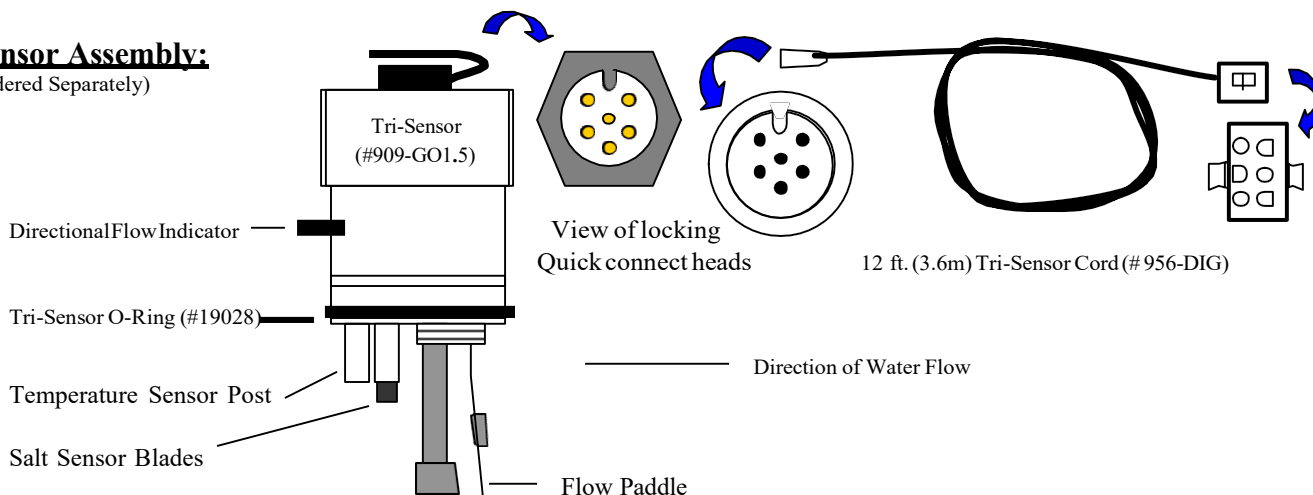

TROUBLESHOOTING

<u>PROBLEM</u>	<u>CAUSE</u>	<u>SOLUTION</u>
1) Insufficient Sanitizer Production.	<ul style="list-style-type: none"> A) The test kit reagents or test strips are old or expired. B) The unit is set too low in relation to sanitizer demand. C) The circulation run time is insufficient. D) The bather load has increased. E) The body of water being sanitized leaks. F) Low Salt. G) “Cell Type” selection not matched to the cell installed. H) Sanitizer loss due to intense sunlight 	<ul style="list-style-type: none"> A) Retest with new Reagents or Strips. B) Increase the Sanitizer % output. C) Increase your pump run time. D) Same solution as (B) and/or add a Non-Chlorine Shock containing Potassium Monopersulfate to supplement. E) Repair the leak and rebalance as needed. F) Check the residual salt level and adjust as needed. G) Follow the INSTALLER SETUP instructions, see page 8. H) Check your stabilizer level and adjust if needed.
2) Scale Build-up within the Cell	<ul style="list-style-type: none"> A) The water being sanitized contains high pH, total alkalinity and calcium hardness levels. (Cell scales within 2 – 3 weeks) B) Power Supply not reversing polarity. (Cell constantly scales within 3 – 5 days) 	<ul style="list-style-type: none"> A) Calculate Langelier’s Index to assure balanced water. Adjust chemicals and clean the Cell. See pages 12 & 13. B) Contact Representative or Authorized Service Centre.
3) DC Plug and Cell Terminals Burned.	<ul style="list-style-type: none"> A) The Cell terminals are wet due to a leaking cell body. B) The Cell plug is not securely pushed onto the cell terminals, allowing moisture to seep into the plug. 	<ul style="list-style-type: none"> A) Contact Representative or Authorized Service Centre. B) Ensure the Cell cord plug is pressed completely onto the Cell terminal. Check the terminals and clean with a dry cloth to remove all dirt and corrosion.
4) Premature Cell Failure (Requires Replacement Cell).	<ul style="list-style-type: none"> A) Abnormally high Cell usage due to an insufficient Stabilizer (Cyanuric acid) level. B) Excessive Scale/Debris in the Cell. C) “Cell Type” selection not matched to the Cell installed. 	<ul style="list-style-type: none"> A) Check the stabilizer level and adjust to recommended levels. B) See Section 2 above. C) Follow the INSTALLER SETUP instructions, see page 8.
5) White Flakes in the Water.	<ul style="list-style-type: none"> A) This occurs when excessive calcium hardness is present. Usually due to water chemistry imbalance. 	<ul style="list-style-type: none"> A) Adjust your water chemistry, visually inspect Cell for scale build-up and clean the cell as described on pages 11 & 13.
6) No Power to the Control Box.	<ul style="list-style-type: none"> A) Internal Fuse blown. B) Circuit Breaker tripped. 	<ul style="list-style-type: none"> A) Check and replace fuse. See page 11. B) Check the power going to the Control Box. Reset the Circuit Breaker.
7) SERVICE Light Flashing	<p>MESSAGE DISPLAYED “CHECK FLOW”</p> <ul style="list-style-type: none"> A) Tri-Sensor Defective. B) Insufficient Flow (Min 94.5 L/min.) (25 US Gallons/min) <p>MESSAGE DISPLAYED “LOW AMPS – CELL?”</p> <ul style="list-style-type: none"> A) Extremely Low Cell Amperage. B) Extremely Low Salt Level. C) The Cell Cord is Loose D) Power Supply as failed. <p>MESSAGE DISPLAYED “CHECK/CLEAN CELL” (Sanitizer still producing)</p> <ul style="list-style-type: none"> A) Excessive Cell Voltage <p>MESSAGE DISPLAYED “LOW SALT - ADD XXX lbs (or kg)”</p> <ul style="list-style-type: none"> A) Salt level Low (below 2,2 gm/l/2200 ppm). 	<ul style="list-style-type: none"> A) Contact Representative or Authorized Service Centre. B) Ensure your Filter and Cell are clean of debris. Check all valves that might divert flow away from the cell. A) Cell heavily scaled. If cell is already clean, replace cell. B) Salt level below 1,5 gm/l (1500 ppm). C) Ensure that the cord is firmly pressed into the cell and the wires properly connected into the banana plugs. D) Contact Representative or Authorized Service Centre. A) Check cell for calcium or scale build-up. Clean as req’d. Water Temperature too cold. Raise above 15.6°C/60°F A) Add the amount of salt shown on the displays

This label transcript service is offered by the Pest Management Regulatory Agency to provide efficient searching for label information. This service and this information do not replace the official hard-copy label. The PMRA does not provide any guarantee or assurance that the information obtained through this service is accurate, current or correct, and is therefore not liable for any loss resulting, directly or indirectly, from reliance upon this service.