



Pool Pilot™
Soft Touch 48
by BIO-LAB CANADA INC.

DOMESTIC
Chlorine Generating Device
Installation and Operation Manual

MODEL ST48 REGISTRATION NUMBER 28064 PEST CONTROL PRODUCTS ACT

**Maximum Output Equivalent To 0.75 Kg. Of Free Available Chlorine Per Day
One ST48 Unit Can Treat a Maximum Of 153,000 Litres Of Swimming Pool Water
Controls Bacteria And Algae In Swimming Pool Waters**

(For Indoor or Outdoor use)

RETAIN MANUAL FOR FUTURE REFERENCE



NSF50

IMPORTANT

READ THE LABEL AND THIS MANUAL BEFORE INSTALLING & OPERATING

Notice to User: This control product is to be used only in accordance with the directions on this label. It is an offense under the Pest Control Products Act to use a control product under unsafe conditions.

Bio-Lab Canada Inc., 1005 Copperstone Drive, Pickering, ON. L1W 4A5

Pool Pilot™

Soft Touch

by BIO-LAB CANADA INC.

Record The Following Information

Installer: _____	Date of Installation: _____
Control Unit Model Number: ST48 _____	Control Unit Serial Number: # _____
Cell Model Number: <u>RC-7</u> _____	Serial Number: # _____

Customer Assistance...

HOTLINE: 1-800-2686572 or 905-686-8836

FAX: 905-619-8696

Manufactured for

Bio-Lab Canada Inc.,

1005 Copperstone Drive, Pickering, ON. L1W 4A5

Pool Pilot™

Soft Touch

by BIO-LAB CANADA INC.

IMPORTANT SAFETY INSTRUCTIONS

READ AND FOLLOW ALL INSTRUCTIONS

INSTALLATION AND EQUIPMENT RELATED

Installation of all MINERAL SPRINGS Pool Pilot™ Soft Touch models:

When installing and using your Pool Pilot™ Soft Touch Control Box, basic safety precautions must always be followed, including the following:

1. Follow all aspects of the local and National Electrical Code(s) when installing your Control Box.
2. During installation, mount your Control Box to ensure the least amount of direct exposure to rain, garden sprinkler water, direct sunlight or any corrosive environment.
3. DANGER – Risk of electrical shock. Install Control Box at least 3 m (10ft.) for 115VAC Units, from the inside wall of the pool or spa using non-metallic plumbing. 1.5 m (5ft.) minimum distance for 230VAC Units.
4. All field-installed metal components such as rails, ladders, drains or similar hardware within 3 m (10ft.) of the spa or hot tub shall be bonded to the equipment grounding bus with copper conductors not smaller than 8.4 mm² (No. 8 AWG) in the U.S.A. and 6.3mm² (No. 6 AWG) in Canada.
5. WARNING – Maintain water chemistry in accordance with manufacturer’s instructions.
6. DANGER – To reduce the risk of injury, do not permit children to use this product unless they are closely supervised at all times. Children should not use spas, hot tubs or pools without permanent adult supervision.

Equipment Related

115/230VAC, 50/60 Hz Models (fixed wiring)

1. A wire connector is provided on your Pool Pilot™ Soft Touch to connect a minimum 8.4 mm² (No. 8 AWG) in the U.S.A. and 6.3mm² (No.6 AWG) in Canada. solid copper bonding conductor between this unit and any metal equipment, metal enclosures of electrical equipment, metal water pipe or conduit within 1.5 m (5ft.) of the unit.
2. A bonding terminal is located inside your Pool Pilot™ Soft Touch. To reduce the risk of electrical shock, this terminal must be connected to the grounding means provided in the electrical supply panel with a continuous copper wire equivalent size to the circuit conductors supplying your Pool Pilot™ Soft Touch.
3. A disconnection device from the power source, with a contact separation of at least 3mm (0.12 in.) in all poles, must be incorporated in the fixed wiring for permanently wired units.
4. The input voltage to the Pool Pilot™ Soft Touch must match the 115/230VAC, 50/60 Hz jumper terminals on the Circuit board, marked “TRANSFORMER PRIMARY”, shown on Page 5.

SAVE THESE INSTRUCTIONS

Table of Contents

Pool Pilot™

Soft Touch

by BIO-LAB CANADA INC.

Section 1 GENERAL INFORMATION

1a	Product Information and Contact Numbers.....	1
1b	Important Safety Instructions.....	2
1c	Table of Contents.....	3

Section 2 INSTALLATION

2a	Main Components.....	4
	Specifications	
2b	Control Box Connections.....	5
	Electrical Connections	
	Cell Cord and Tri-Sensor Connections	
	ORP Connections	
2c	Cell and Manifold Installation.....	6
	Verification of Flow Switch Protection.....	6

Section 3 OPERATION

3a	Key Features – Control Panel.....	7
3b	Pool Water Preparation.....	8
	Salt Requirement Chart	
	Start-Up Procedures.....	8
3c	Monitoring and Maintenance.....	9
	Water Chemistry Parameters	
	Saturation Index	

Section 4 SERVICE and MAINTENANCE

4a	Servicing.....	10
	Control Box	
	Tri-Sensor	
4b	Servicing.....	11
	Cell Removal	
	Cell Maintenance and Cleaning	
	Filter Backwashing.....	11
4c	Parts Explosion.....	12

Section 5 TROUBLESHOOTING

5a	Troubleshooting.....	13
----	----------------------	----

Appendix	Diagnostics.....	14
-----------------	------------------	----

Main Components

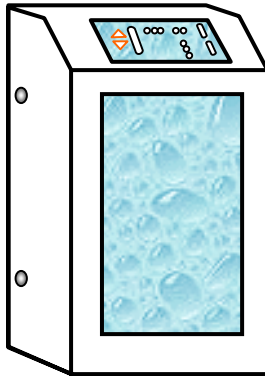

Soft Touch Control Box

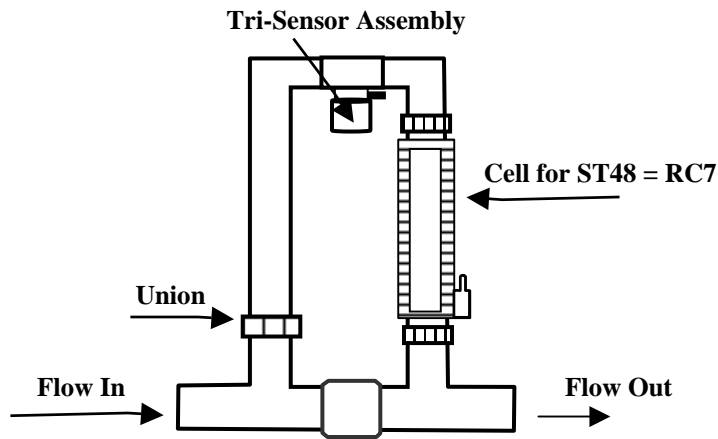

CONTROL BOX converts incoming AC power to a Low Voltage DC current, which energizes the Cell(s). Set the **Control Box** on a vertical surface away from excessive exposure to heat and moisture. Use the template to mark and drill the (4) mounting holes and insert the screws, leaving a ¼ in. gap. Hang the control box on the screws and level. Remove the cover by following the steps on page 10 to access the mounting holes to tighten the screws.

RATINGS:

Input Power: 115 VAC (3.0 AC amps)
230 VAC (1.5 AC amps)
50/60 Hz

Output Power: Cell Power 1 (5.0* DC amps)
Cell Power 2 (6.5* DC amps)
Cell Power 3 (8.0* DC amps)

*Indicates nominal amperage output. The dual axis controller will slightly vary the amps to optimize the power to the cell.

ELECTROLYTIC SUPERCCELL receives Low Voltage DC current from the Power Circuit Board, which initiates the electrolytic process. This process converts ordinary table salt (Sodium Chloride) to 100% Pure Sodium Hypochlorite (Chlorine Bleach) or Bromine (with the addition of Sodium Bromide), which in turn sanitizes your pool or spa. See page 8 for salt requirements.

Maximum Output: Equivalent to 0.75 kg (1.65 lbs) of free available chlorine/day RC-7 CELL @ Cell Power Level 3 (8 amps DC)

Cell Life Expectancy: A minimum of 15,000 ampere/hours

Agency Approvals: NSF, ETL us, ETL c, CE

TRI-SENSOR ASSEMBLY ensures that adequate **flow** 94.5 L/min (25US Gallons/min) minimum; **salt**, 2,8 – 3,2 gm/l (2800–3200 ppm) ideal range; and **water temperatures**, above 15.6°C (60°F) are satisfactory to prevent abusive conditions for the cell to operate. See page 10 for instructions to remove and inspect the tri-sensor assembly.

The cell and tri-sensor are located in a Patented Automatic Flow Bypass Manifold Assembly. 3.6m (12ft.) of **Cell and Tri-Sensor cords** are provided with the unit. Ensure that the manifold is located within that distance from the control box with enough slack to allow for removal for service or maintenance.

CAUTION: It is suggested to locate the cell downstream of all other equipment and on the pool return line only to avoid over-saturation conditions of your spa. For applications other than as recommended, contact the factory.

Control Box Connections

Electrical Connections

BIO-LAB recommends that a licensed electrician or certified electrical contractor perform the electrical connections.

DANGER: ensure that the electrical panel or filter pump circuit breaker is turned OFF before wiring this unit.

Your Pool Pilot™ *Soft Touch* Control Box comes pre-wired from the factory for 230VAC (1.5 amps max draw) and can also operate on 115 VAC, (3.0 amps max draw) at 50/60Hz. 1.8m (6ft.) of AC lead wires are provided with the unit and are located on the bottom base plate of the control box along with the Cell, Tri-Sensor and optional ORP Interface connections.

Converting to 115VAC is accomplished by accessing the circuit board, rewiring, and attaching the included jumper as shown below. Remove the cover (see page 10) to access and ensure that the Jumper Connections on the circuit board marked “TRANSFORMER PRIMARY” are matched to the LINE IN voltage. Follow all state/local codes for electrical installations.

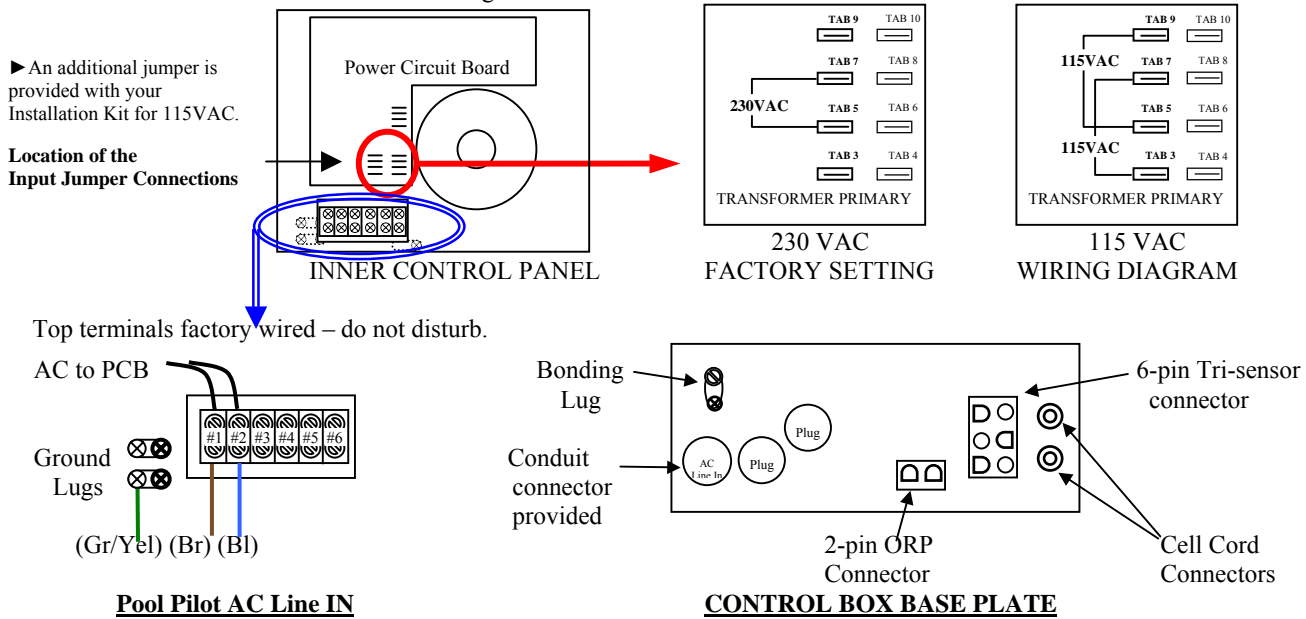

AC LINE IN (Wiring diagram also located on inside of cover):

For 230 VAC; Brown (Br) = Line 1, Blue (Bl) = Line 2, Green w/Yellow Tracer (Gr/Yel) = Earth Ground

For 115 VAC; Brown (Br) = Line, Blue (Bl) = Neutral, Green w/Yellow tracer (Gr/Yel) = Earth Ground

The AC Line IN wiring is pre-set for connection to the **LINE SIDE** of your time clock, electronic controller switch or relay to work in conjunction with your circulation pump.

Cell Cord. Each Cell Cord contains (2) Banana Plugs that attach to the (2) Banana Jacks on the bottom of the Control Box.

Polarity does not matter. The other end of the cell cord has a three-position plug that connects to the cell in any direction. See page 11 for service instructions.

Tri-Sensor Cord. The Tri-Sensor Cord connects to the keyed 6-pin harness on the Control Box Base Plate. The opposite end of the cord connects to the Tri-Sensor Assembly with a locking ring quick connect. Align the groove and keyway on the connector and twist the locking ring to ensure a proper connection. Refer to the instructions on pages 10 & 12 for diagrams and additional instructions.

ORP Connection. When an ORP Chemical Controller is interfaced to your Pool Pilot™ *Soft Touch*, the Chemical Controller will remotely control the SANITIZER Output. Adjust the output level to 0% and connect the ORP controller to the 2-pin connector on the Control Box Base Plate. When the ORP is activated, the output will indicate ON with the display showing 0%.

WARNING: THE ORP CONNECTIONS ARE DRY CONTACT INPUTS, DO NOT ENERGIZE THESE INPUTS! DAMAGE TO THE CONTROL BOX WILL OCCUR AND WILL VOID THE WARRANTY.

Cell and Manifold Installation

Your Lectranator System is adaptable for use with the 7 blade (RC-7) cell. The manifold must be located as the last accessory in the **POOL RETURN LINE** only. For special plumbing configurations, please contact your representative for assistance in locating the manifold.

Standard Manifold Assembly:

Bypass flow rate should be set at 94.5 L/min (25 US Gallons/min).

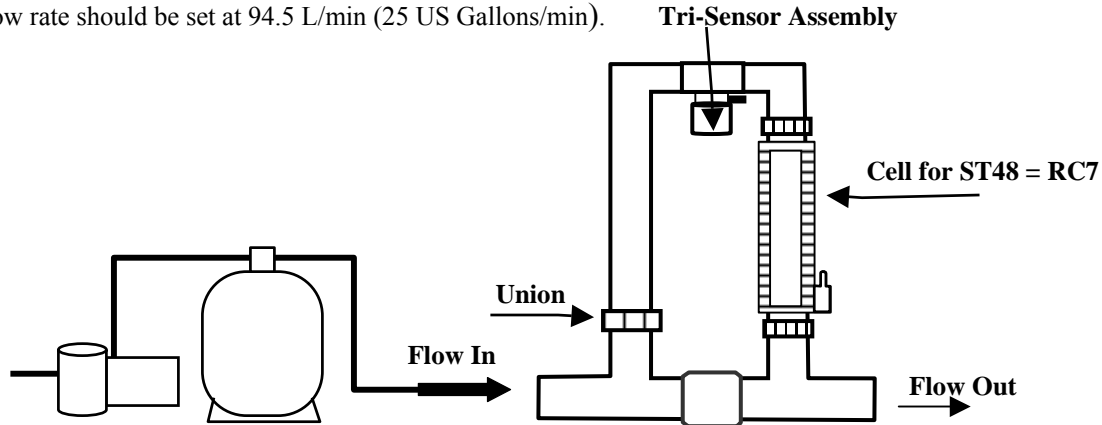

For other plumbing configurations, please contact your representative for assistance.

Verification of Flow Switch Protection:

It is important to **ANNUALLY** inspect and verify the safe and proper operation of the Tri-sensor's Flow Switch protection device. We recommend following this procedure to verify that the flow switch is working as designed, which is to halt power from being sent to the cell in the presence of insufficient flow. A defective Flow Switch could cause serious personal and/or equipment damage. Using either a **GOLF BALL** or small plastic wrap (saran wrap, food wrap or zip lock bag), block off flow to the upper portion of the manifold by placing the golf ball in the strainer screen union or by wrapping the strainer screen with the plastic wrap and placing it back in the union and tightening. Operating the system on with this blockage should detect a **FLOW** obstruction, indicated on the digital display and activating a red flashing **CHECK SYSTEM** light. Once this protection feature has been verified, remove the plastic wrap or golf ball, replace the strainer screen and resume operation. Turn the output dial to **OFF** and contact the factory if the flow switch protection is not working properly.

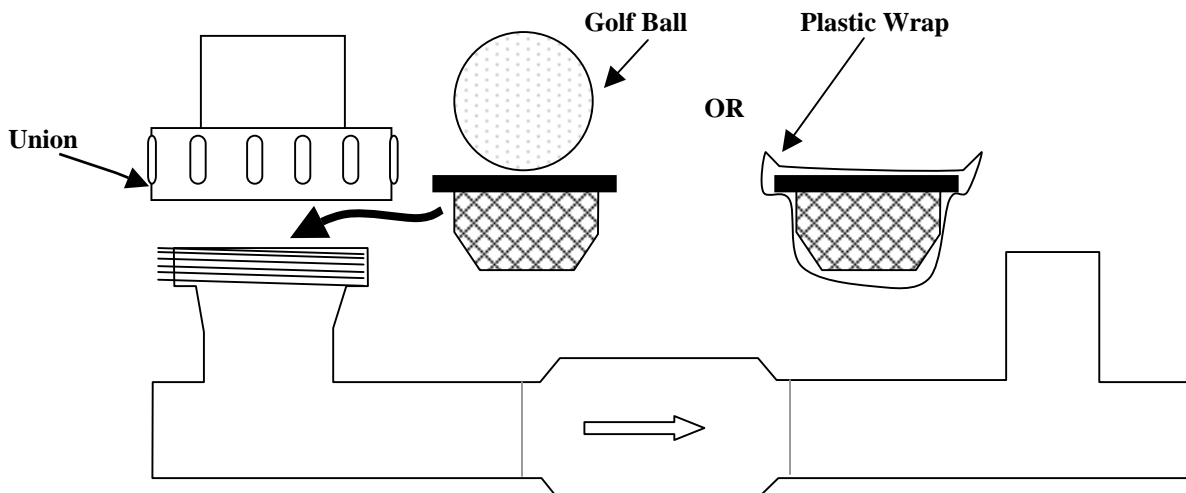

Key Features

The **Control Panel Display** provides a series of control buttons for **OUTPUT** level, **BOOST** mode and **SETUP** functions, with diagnostic indicator lights for **FLOW-OK**, **100% SALT** and **SERVICE**. Two additional indicator lights show the selected setup **CELL POWER** and **REVERSING** cycle.

The Pool Pilot™ *Soft Touch* SANITIZER **OUTPUT** level is adjustable from 0% (OFF) to 100%(MAX). Press the **Up/Down Arrows** to set the desired output level. Little adjustment is needed once the initial setting is established.

The selected output level will remain steady when the system is at rest and will begin pulsing when the system is producing the SANITIZING agent. **Note: The Pool Pilot™ *Soft Touch* does not test for SANITIZER levels nor automatically adjust to maintain a desired SANITIZER level. This is done by periodically testing the water and adjusting the output levels up or down, as needed.**

The Pool Pilot *Soft Touch* is designed with an **AUTOMATIC TEMPERATURE COMPENSATION** feature, which automatically adjusts the output level setting based upon changes in seasonal water temperatures only. This unique feature conveniently compensates for warm (more SANITIZER needed) or cold (less SANITIZER needed) water conditions.

The **SETUP Mode** allows the user to program the **CELL POWER** and **REVERSING** cycle. To enter Setup Mode, press and hold the concealed Setup button (small bubble adjacent to the Salt OK light) until the **CELL POWER** light begins flashing. The Pool Pilot™ *Soft Touch* is set on “2” from the factory. Use the Up/Down Arrows to change the Cell Power setting if needed. Adjust the OUTPUT level at the new setting to maintain proper sanitizer levels.

WARNING: Operating on “1” reduces cell power but extends cell life; “3” increases cell power but reduces cell life.

Pressing the Setup Button once more will go to the **REVERSING** cycle. The Pool Pilot™ *Soft Touch* is set on “NORMAL” from the factory for ideal cell life. Use the Up/Down Arrows to select the Reversing cycle. For conditions such as extremely high calcium levels or conditions that can cause the cell to scale quicker than the self-cleaning cycle can control, change the setting to “SHORT”. For optimum water chemistry balance according to the Saturation Index, see page 9, you can change the REVERSING cycle to “LONG”. Pressing the setup button once more will leave the Setup Mode and save the programmed Cell Power and Reversing settings. Test your water chemistry parameters monthly and compare to the Saturation Index.

WARNING: Changing the Reversing cycle to SHORT will also reduce cell life. However, operating the cell under scaled conditions on “Normal” or “Long” is more detrimental to the life of the cell and changing the Reverse cycle is suggested.

The **BOOST Button** activates the Boost light when it is pressed once. This light indicates that the system is in Boost Mode and will produce the SANITIZING agent for 24 hours. The SANITIZING agent can be produced for 72-hours by pressing and holding the BOOST button for 5-seconds from the Boost-Off position. This is called the **Super-Boost Mode**. A flashing Boost light indicates that the system has successfully entered this mode. In either mode, the SANITIZING agent is produced continuously, throughout the normal On/Off cycles of the pump and throughout all power line disturbances at an output SANITIZING level of 100% regardless of the normal SANITIZING output level setting. The system will discontinue operation of the Boost mode or Super Boost mode if the boost button is pressed once more and return to the normal SANITIZING output level setting. The pool/spa pump must be turned on during the whole boost cycle. Do not let the pump run on a timer during that period.

The **SALT** light indicates the salt level in the water. The salt level should be maintained between 2.8 – 3.2 g/l (2800 – 3200 ppm). The **SALT-OK** light will be on if this salt level is achieved. If the salt level drops below 2.5 g/l (2500 ppm), the **SALT-LOW** light will turn on and the system will continue to produce the SANITIZING agent. If the salt level drops below a safe value, the **SALT-ADD** light will turn on and the system will no longer continue to produce the SANITIZING agent.

(NOTE Maintaining high salt levels above recommended range can contribute to corrosion of pool/spa equipment. Salt levels exceeding the recommended concentration can be reduced by diluting the pool/spa with fresh water.) See Appendix (page 14) to determine your salt level.

The **FLOW-OK** light turns on when there is sufficient flow. Any problems with insufficient water flow is indicated by a Flow-OK light that is not on and a Flashing Service Light (single flash pattern).

The **SERVICE** light flashes when service is needed. A Single flash pattern of the service light indicates insufficient water Flow. A Double flash pattern of the service light indicates high cell volts and low amps, which is caused by a scaled or failing cell or a loose/defective cell cord. A Triple flash pattern of the service light indicates high cell volts and low amps, which is caused by a failed power supply. A Quadruple flash pattern of the service light indicates a failed tri-sensor or cord.

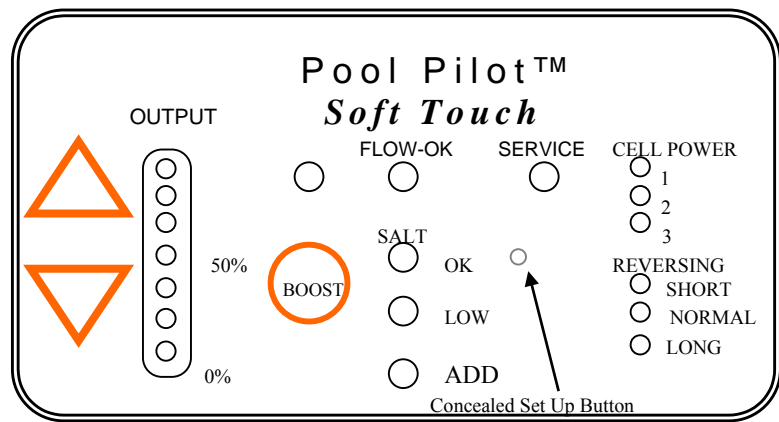

Pool Water Preparation

Salt Requirements

It is important that with typical pools, a salt residual of 2.8 – 3.2 g/l (2800 to 3200 ppm) be maintained at all times for peak efficiency. **NOTE:** Maintaining high salt levels above recommended range can contribute to corrosion of pool/spa equipment. Salt levels exceeding the recommended concentration can be reduced by diluting the pool/spa with fresh water.

The amount of salt required depends on the size of the pool and the present salt level. As the salt is being added, we recommend running the circulation pump continually for 24 hours with the main drain opened. Brushing the salt towards the bottom main drain will assist in the dissolve rate and prevent possible staining with certain types of salt.

We recommend the use of a specialty blended salt product that does not contain Yellow Prussiate of Soda (YPS) or Iodine which could cause a localized tint to the water or brown staining on the cementitious finish if allowed to rest undissolved on the finish for extended periods of time.

Granular Salt, Table Salt, Solar Salt or Water Conditioner Pellets can also be used but will have different dissolve rates. If the salt you use contains Iodine or YPS, constant brushing will help the dissolve rate and prevent staining due to the additives in the salt. Ensure that the salt you use contain a minimum purity of 99% Sodium Chloride (NaCl).

NOTE: Do not use Rock Salt due to its high levels of impurities.

TEST YOUR WATER FOR SALT LEVEL FIRST with the provided salt test strips, and then use the chart below to determine the amount of salt to add.

SALT REQUIREMENT CHART

KILOS (LBS.) OF SALT NEEDED FOR 3000 PPM RESIDUAL								
SALT Level Before Addition	Pool Volume in Liters (US Gallons)							
	3,780 (1,000)	9,430 (2,500)	18,900 (5,000)	28,300 (7,000)	37,780 (10,000)	56,700 (15,000)	75,600 (20,000)	113,600 (30,000)
0 ppm	11.3 (25)	28 (63)	57 (126)	85 (175)	113 (252)	175 (378)	227 (504)	340 (756)
500 ppm	9.5 (21)	24 (53)	48 (106)	73 (147)	95 (212)	145 (318)	191 (424)	286 (636)
750 ppm	8.6 (19)	22 (48)	43 (96)	66 (133)	86 (192)	130 (288)	173 (384)	259 (576)
1000 ppm	7.7 (17)	19 (43)	39 (86)	54 (119)	77 (172)	116 (258)	155 (344)	232 (516)
1500 ppm	5.9 (13)	15 (33)	30 (66)	41 (91)	59 (132)	89 (198)	119 (264)	178 (396)
2000 ppm	3.6 (8)	9.5 (21)	19 (42)	30 (56)	38 (84)	57 (126)	76 (168)	113 (252)
2250 ppm	2.7 (6)	7 (15)	14 (30)	19 (42)	28 (60)	41 (90)	54 (120)	81 (180)

Note: The above chart is based on 120 grams of salt added to 1000 Liters of water (1 lb. per 1,000 gallons) to increase your salt residual 120-ppm.

Start Up Procedures

Keep the Output Setting on your Pool Pilot™ *Soft Touch* on 0% (OFF) until you get your water clear, blue and properly balanced.

1. After balancing your water chemistry according to the Water Chemistry Parameters shown on page 9, add the proper amount of salt (see Salt Requirement Chart above) and circulate 24-hours prior to starting your Pool Pilot™ *Soft Touch*.
2. The following day, turn your Output Level to 50% and operate normally. Test water as required to conform with local health code. Raise or lower output control setting as needed.
3. Once your Output Level has been established, you will only need to adjust your level according to increased bather usage.

Section 3c – OPERATION

Monitoring and Maintenance

Water Chemistry Parameters - VERY IMPORTANT NOTE! Your Pool Pilot™ *Soft Touch* is designed to provide SANITIZER on a daily basis. We recommend the following water chemistry ranges and periodic checks to monitor your systems efficiency. Always follow all local and state requirements. Check the expiry date of the test kit as test results may be inaccurate if used after that date.

Daily Checks:		Monthly Checks:			
Free Chlorine:	1.0 – 3.0 PPM (pool)	Calcium Hardness:	200 – 300 PPM (pool) 150-200 (spa)	Salt Residual::	2800 – 3200 PPM
Or Bromine:	1.0 – 3.0 PPM (pool)	Total Alkalinity:	100 – 120 PPM (pool & spa)	Saturation Index:	± 0.3 pH of saturation
Free Chlorine:	3.0 – 5.0 PPM (spa)	Cyanuric Acid:	30 –100 PPM (pool & spa)	Visual Cell Inspection	for wear, scale or debris
Free Bromine:	3.0 – 5.0 PPM (spa)				
pH:	7.2 – 7.8				

CHLORINE/BROMINE REQUIREMENTS: During Peak SANITIZER Demand (rainy season or heavy bather usage) it may be necessary to increase your SANITIZER level by increasing your Output Level setting and/or pump run time. Conversely, during Low SANITIZER Demand, you can decrease your Output Level to a lower setting. For extremely Heavy SANITIZER Demand or to boost your SANITIZER levels quickly, you can **Boost** the system or supplement with a Potassium Monopersulfate based shock. If the water is clear but is difficult getting a bromine residual using DPD or test strips, we recommend using an OTO test kit.

NOTE: During cold-water conditions, below 60°F, SANITIZER demand is reduced significantly. For colder climate regions with sustained low or freezing temperatures, contact your local pool professional for proper pool winterizing instructions.

WARNING: Excessive chlorine levels can cause corrosion damage to stainless steel rails, ladders, heater heat exchangers, light faceplates and other metallic equipment. Avoid over saturation of chlorine levels. The output setting must be sufficiently high to maintain the recommended chlorine residual in the swimming pool/spa water. Provincial and/or municipal regulation must be followed.

pH: When pH levels fall below the recommended range, SANITIZER is used up quickly and can be damaging to equipment. For pH levels higher than the recommended range, SANITIZER becomes less effective and works harder to keep your pool sanitized. Improper pH also contributes to the strong smell, red eyes, dry itchy skin and brittle hair conditions associated with “too much Chlorine”.

CALCIUM HARDNESS AND TOTAL ALKALINITY: Your Pool Pilot™ *Soft Touch* provides 100% pure sodium hypochlorite and does not affect the calcium hardness or total alkalinity levels. Maintain and balance only as needed.

CYANURIC ACID (STABILIZER/CONDITIONER): This chemical goes by either trade name and allows the chlorine residual to last longer by protecting it from the UV degradation of the sun. With low or no Cyanuric acid it is possible for the chlorine to be used up as quickly as it enters the pool. Check and maintain your cyanuric acid levels at the same time as your salt level, as these tend to deplete at the same rate. Regulations may exist regarding the use of cyanuric acid; please consult your local authority. **NOTE: For Bromine or indoor pools, it is not necessary to add stabilizer.**

SALT RESIDUAL: Your Pool Pilot™ *Soft Touch* works most efficiently with salt levels between 2.8 – 3.2 g/l (2800- 3200 ppm). If it falls below 2.8 g/l (2800 ppm), determine the salt level and adjust according to the SALT REQUIREMENT. Low salt will cause premature deterioration of the Cell blades. Maintaining high salt levels above recommended range can contribute to corrosion of pool/spa equipment. Salt levels exceeding the recommended concentration can be reduced by diluting the pool/spa with fresh water.

BROMINE RESIDUAL: Along with the normal Salt level, add 0.45 kg (1 lb) Sodium Bromide (NaBr) per 7500 L (2000 gallons) of water. Your Pool Pilot™ *Soft Touch* will now generate Bromine to purify your pool. Maintain your bromine level by checking your salt level. Once your salt falls below the recommended range, we suggest you add 0.45 kg (1 lb) sodium bromide with every 22.5 kg (50 lbs) of salt added. Always use a registered or scheduled source of sodium bromine..

SATURATION INDEX (Si): a formula used to ensure that your total water chemistry does not fall into a scale forming or corrosive condition. Either condition can cause premature damage to the Cell, equipment and cementitious finish. Have your water professionally tested periodically according to the Saturation Index or use this chart to determine your water balance.

$$Si = pH + TF + CF + AF - \text{Constant}$$

Temperature	TF	Calcium Hardness	CF	Total Alkalinity	AF	TDS	Constant
15.6C 60F	0.4	150	1.8	75	1.9	0 – 1000	12.1
18.9C 66F	0.5	200	1.9	100	2.0	1001 - 2000	12.2
24.4C 76F	0.6	250	2.0	125	2.1	2001 - 3000	12.3
28.9C 84F	0.7	300	2.1	150	2.2	3001 - 4000	12.4
34.4C 94F	0.8	400	2.2	200	2.3	4001 - 5000	12.5
39.4C 103F	0.9	600	2.4	250	2.4	5001 - 6000	12.6

Test your water for pH, Calcium Hardness, Total Alkalinity and TDS levels. Use the equivalent Factor in the Si equation.

Si = ±0.3; balanced

Si above + 0.3; scaling, staining or cloudy water conditions.

Si below -0.3; corrosive to metals, etches/deteriorates plaster finishes or skin irritating conditions.

DO NOT add pool/spa chemicals directly to the skimmer. This may damage the cell.

Section 3c OPERATION (cont'd)

Additional notes:

- For proper sanitation, spa must be completely drained periodically. The number of days between COMPLETE SPA DRAINAGE is equal to the volume of spa water in liters, divided by 10 times the maximum number of daily spa users.
- Maximum spa usage temperature is 40°C (104°F). Duration in spa water at 40°C should not exceed 15 minutes.
- Heavy use of the spa (excessive contamination) may require longer recovery times (A return to a minimum of 3 ppm chlorine/bromine). Recovery time may be reduced by adding a shock compound to the water.
- Hot weather, heavy pool usage, and rain may require a higher output to maintain proper sanitizer residual.

Section 4a –SERVICE and MAINTENANCE

CONTROL BOX

There are little serviceable parts on the Pool Pilot™ *Soft Touch* Control Box except the fuses. For any other problems with the Control Box, please contact the Factory or Authorized Dealer/Service Center.

To remove the Control Box Cover and access the fuses, follow these steps.

DANGER: TURN OFF THE POWER FROM THE CIRCUIT BREAKER BEFORE SERVICING THIS UNIT.

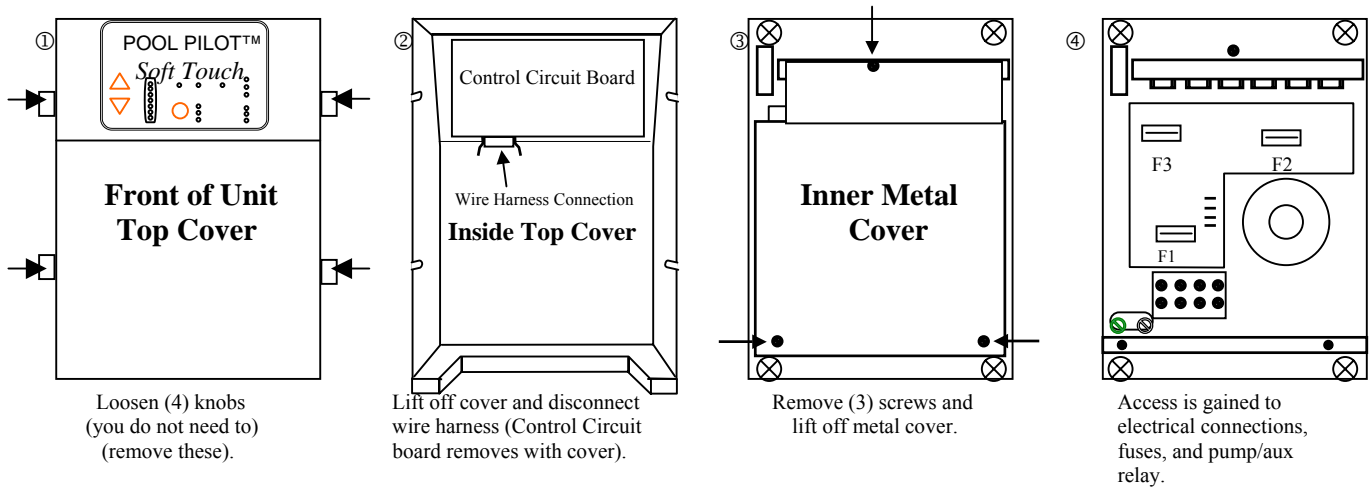

Fuse Location and Ratings

F1	Main AC Power Fuse	6 Amps 250 VAC
F2	Control Panel Circuit Board Fuse	3 Amps 250 VAC
F3	Cell Fuse	20 Amps 250 VAC

TRI-SENSOR ASSEMBLY

The Tri-sensor assembly tests for Flow, Salt and Water temperatures. A minimum flow rate of 94.5 L/min (25 US Gallons/min) is required to activate the flow switch. As the water flow closes the paddle, a magnet activates a micro switch to verify proper flow. The Salt sensor protects against low salt levels and the temperature sensor protects against cold water temperatures. Both of which can contribute to accelerated cell failure.

Note: The use of high strength magnet devices in the close proximity of the tri-sensor can cause the flow switch to read incorrectly.

Remove the Tri-Sensor as follows (with pump off):

Remove both screws from the sides of the Tee Assembly. With the aid of large Channel-lok® (or similar) pliers, firmly grip the Tri-Sensor assembly and move back and forth while removing the Tri-Sensor from the tee. Inspect the thin metallic paddle for erosion and straightness. Take care not to twist or tweak this paddle, which can cause inaccurate flow readings. Inspect the salt sensor blades for scale and debris and clean if necessary. See page 13 for cleaning instructions. Follow the directions for Manual Cell Cleaning. Check the tri-sensor assembly for any damage to the plastic housing and replace if needed.

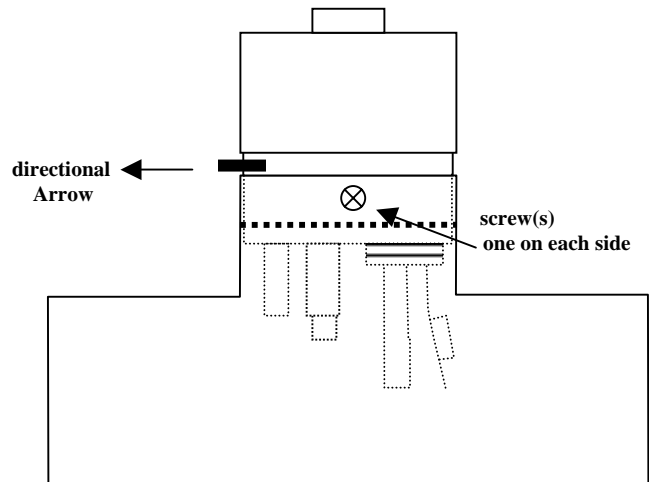

Cell

The Cell is installed with Unions on each end of the cell to allow quick and easy removal. Loosen the unions and remove the cell from the plumbing.

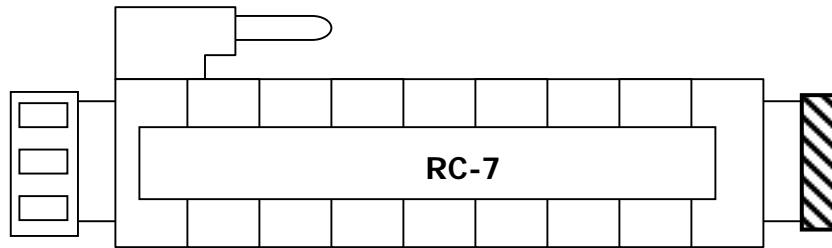

Side View of Cell and Unions

VISUAL CELL INSPECTION:

The titanium Cell blades, seen inside the Cell body, should be straight and clear of any debris between the blades. Your Pool Pilot™ *Soft Touch* is designed to automatically self-clean calcium scale build-up within the Cell. However, imbalanced water chemistry and certain conditions can cause a heavier scale build up that exceeds the self-cleaning capability and would need to be cleaned manually by the method described below.

Periodically inspect both ends of the cell. A White Flaky or Crusty build-up on the edge or between the blades will prematurely deplete the life of the cell. Immediately clean the cell and determine the cause of scaling. See Troubleshooting Section, page 13.

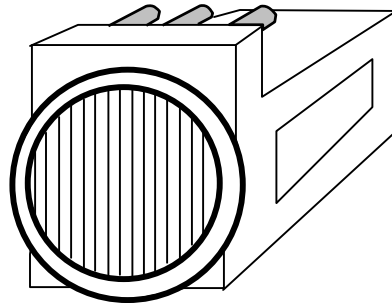

End View of cell
Looking at the Titanium Blades

MANUAL CELL CLEANING:

With the Cell removed as described above, use a high-pressure hose nozzle to spray off as much loose, soft scale and debris as possible. Any remaining calcium scale can be treated with a mixture of one (1) part Muriatic Acid into four (4) parts water. Mix the solution in a container high enough to cover the Cell blades. You may also use a non-fuming/pre-mixed cell cleaner, per label directions.

Remove the Cell cord and immerse the Cell so that the blades are completely covered in the solution for up to 15 minutes. An effervescences action indicates the calcium is being neutralized and cleaned. Drain the cell, flush with fresh water and re-inspect. Repeat the immersion if necessary. Once the cell has been cleaned and rinsed; it may be re-installed in-line. **BE SURE THAT THE CELL “PINS” ARE CLEAN AND DRY BEFORE ATTACHING THE DC CORD FROM THE POWER SUPPLY. WARNING: ALWAYS ADD ACID TO WATER, never water to acid.**

When replacing the cell, only use replacement cells having a label that clearly states that it is a replacement cell for the chlorine generating device MINERAL SPRINGS Soft Touch Model ST48, REGISTRATION NUMBER 28064, PEST CONTROL PRODUCTS ACT.

WARNING: ALWAYS ADD ACID TO WATER, never water to acid.

NEVER USE ANY SHARP OR METALLIC OBJECTS TO REMOVE SCALE. Scraping or scratching the titanium blade’s edge or surface will allow chemical attack of the blade, cause premature failure of the Cell and will void your warranty.

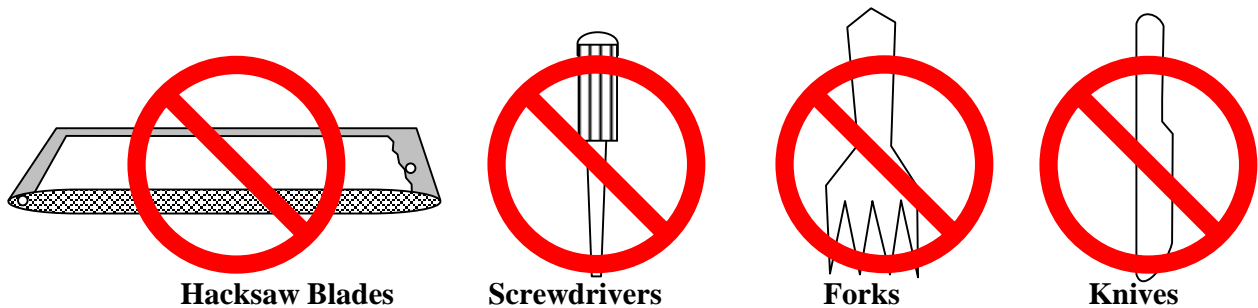

Hacksaw Blades

Screwdrivers

Forks

Knives

FILTER BACKWASHING:

The Control Panel Output setting must be set to 0% (OFF) when backwashing the filter.

Parts Explosion

Manifold Assembly:

(#941)

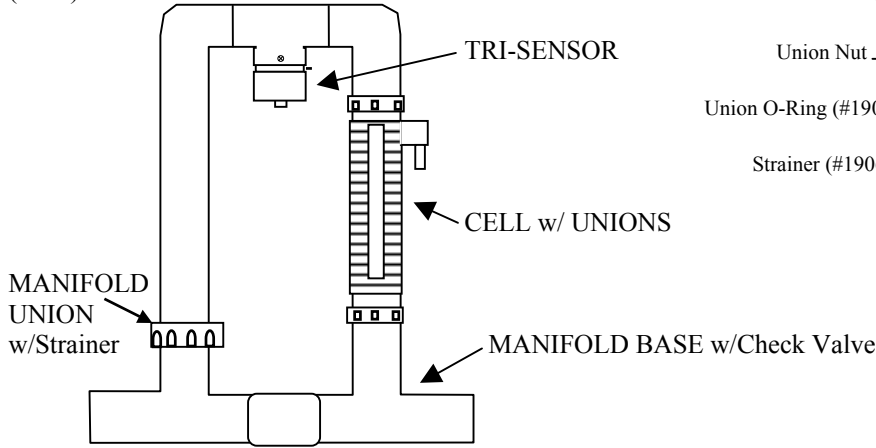

Manifold Union w/Strainer:

(#19065)

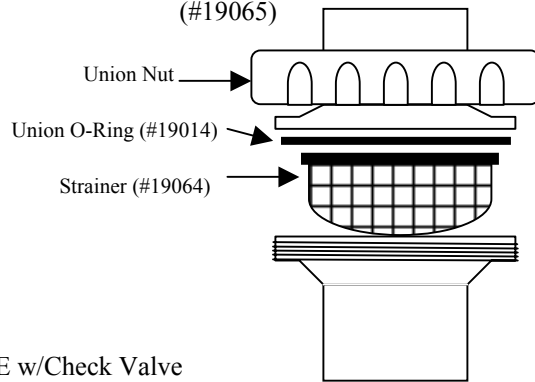

Electrolytic Cell:

(Cell Unions and Cord ordered separately)

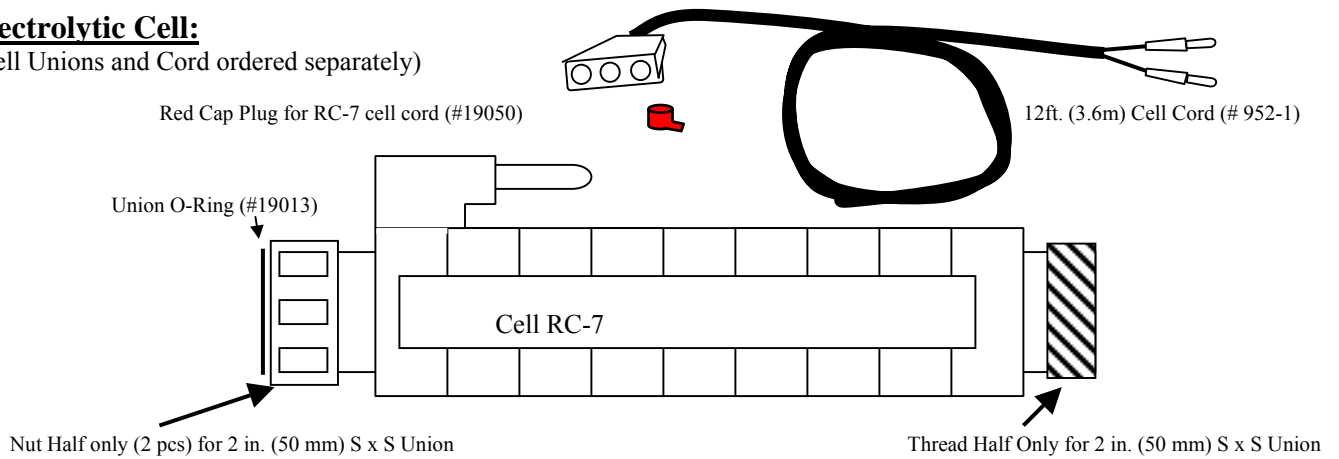

Tri-Sensor Assembly:

(Cord Ordered Separately)

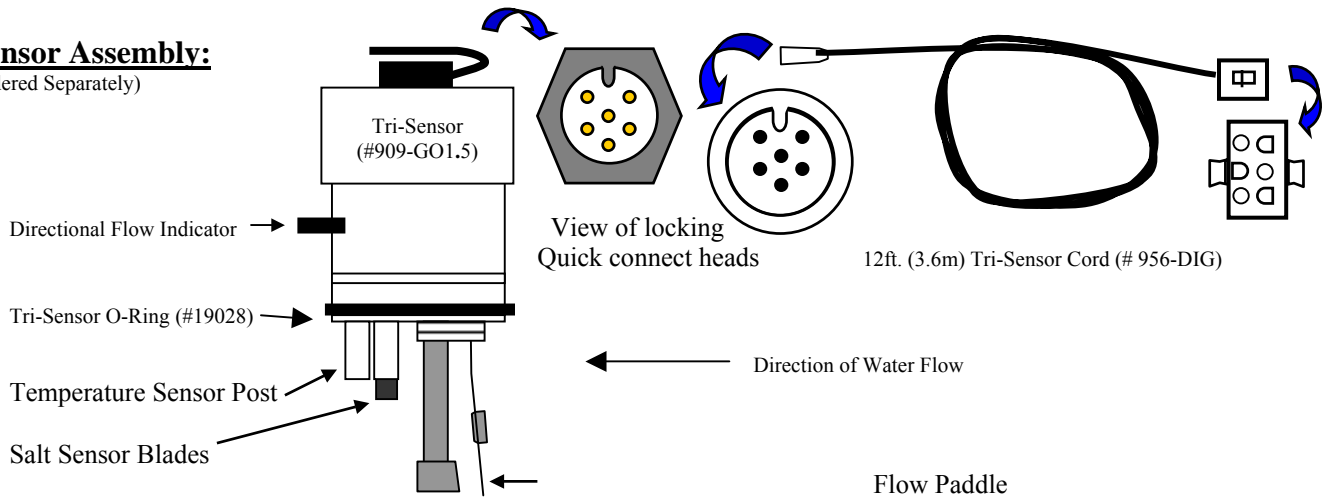

TRUBLESHOOTING

<u>PROBLEM</u>	<u>CAUSE</u>	<u>SOLUTION</u>
1) Insufficient SANITIZER Production.	<p>A) The test kit reagents or test strips are old or expired.</p> <p>B) The unit is set too low in relation to SANITIZER demand.</p> <p>C) The circulation run time is insufficient.</p> <p>D) The bather load has increased.</p> <p>E) The body of water being sanitized leaks.</p> <p>F) Low Salt.</p> <p>G) “Cell Power” selection not matched to the cell installed.</p> <p>H) SANITIZER loss due to intense sunlight</p>	<p>A) Retest with new Reagents or Strips.</p> <p>B) Turn up the output setting.</p> <p>C) Increase your pump run time.</p> <p>D) Same solution as (B) or add a Non-Chlorine Shock containing Potassium Monopersulfate to supplement.</p> <p>E) Repair the leak and rebalance as needed.</p> <p>F) Check the residual salt level and adjust as needed.</p> <p>G) Follow the SET UP procedures to match the cell, see page 7.</p> <p>H) Check your stabilizer level and adjust if needed.</p>
2) Scale Build-up within the Cell.	<p>A) The water being sanitized contains high pH, total alkalinity and calcium hardness levels. (Cell scales within 2 – 3 weeks)</p> <p>B) Power Supply not reversing polarity. (Cell constantly scales within 3 – 5 days)</p>	<p>A) Calculate Saturation Index to assure balanced water. Adjust chemicals and clean the Cell. See pages 9 & 11.</p> <p>B) Contact the factory for Warranty Status/Procedures.</p>
3) DC Plug and Cell Terminals Burned.	<p>A) The Cell terminals are wet due to a leaking cell body.</p> <p>B) The Cell plug is not securely pushed onto the cell terminals, allowing moisture to seep into the plug.</p>	<p>A) Contact the factory for Warranty Status/Procedures.</p> <p>B) Ensure the Cell cord plug is pressed completely onto the Cell terminal. Check the terminals and clean with a dry cloth to remove all dirt and corrosion.</p>
4) Premature Cell Failure (Requires Replacement Cell).	<p>A) Abnormally high Cell usage due to an insufficient Stabilizer (Cyanuric acid) level.</p> <p>B) Excessive Scale/Debris in the Cell.</p> <p>C) “Cell Power” selection not matched to the Cell installed.</p>	<p>A) Check the stabilizer level and adjust to recommended levels.</p> <p>B) See Section 2 above.</p> <p>C) Follow the SETUP procedures to match the cell, see page 7.</p>
5) White Flakes in the Water.	<p>A) This occurs when excessive calcium hardness is present. Usually due to water chemistry imbalance.</p>	<p>A) Visually inspect Cell for scale build-up and clean the cell as described on page 11. Adjust your water chemistry.</p>
6) No Power to the Control Box.	<p>A) Internal Fuse blown.</p> <p>B) Circuit Breaker tripped.</p>	<p>A) Check and replace fuse. See page 10.</p> <p>B) Check the power going to the Control Box. Reset the Circuit Breaker.</p>
7) SERVICE Light (Single RED Flash and Flow-OK light off).	<p>A) Tri-Sensor Defective.</p> <p>B) Insufficient Flow Min. (94.5 L/min) (25 US Gallons/min)</p>	<p>A) Contact the factory for Warranty Status/Procedures.</p> <p>B) Ensure your Filter and Cell are clean of debris. Check all valves that might divert flow away from the cell.</p>
8) SERVICE Light (Double RED Flash)(SANITIZER is producing).	<p>A) High Cell Volts with Low Amps</p>	<p>A) Check cell for calcium build-up or scale deposits. Cell is depleted and needs replacement. Cell cord is loose or defective. Ensure that the cord is firmly attached to the cell. Check the Banana Plug connections.</p>
9) SERVICE Light (Triple RED Flash)(SANITIZER production halted). (Microprocessor version V1.4 or older)	<p>A) High Cell volts with Extremely Low Amps.</p>	<p>A) Heavily scaled cell or failed cell.</p>
	(Microprocessor version V1.5 or newer)	
	A) Improperly wired or failed Power Supply.	A) Ensure voltage input matches wiring connection (page 5).
10) SERVICE Light (Quadruple RED Flash)(SANITIZER is producing).	<p>A) Tri-sensor or tri-sensor cord is loose or defective.</p>	<p>A) Inspect and tighten or replace.</p>
11) LOW SALT Light activated (SANITIZER is producing) .	<p>A) Salt level Low (below 2,5 g/l (2500 ppm)).</p>	<p>A) Check with Salt test strips or meter and adjust as needed.</p>
12) ADD SALT Light activated (SANITIZER production halted).	<p>A) Salt level extremely low (below 2.0 g/l (2000 ppm)).</p>	<p>A) Check with Salt test strips or meter and adjust as needed.</p>
13) Unable to set output to a high level.	<p>A) Temperature is too low (below 15.6C (60F)).</p>	<p>A) The Pool Pilot has limited output to protect the cell.</p>

BUILT-IN DIAGNOSTICS

The Pool Pilot™ Soft Touch Control Box contains a way to display a diagnostic report on its operation. It allows the user to view the salt concentration, the water temperature, and the Electrolytic Cell voltage and amperage. This is provided for a technician to evaluate the performance of the Pool Pilot without the need for special equipment. The values are measured by counting the number of flashes of the lights, as described below.

To access and interpret the diagnostics, follow this procedure:

To start the diagnostic procedure, press and hold both the UP and DOWN buttons at the same time. Hold them pressed until the output display lights go out, leaving just the bottom light illuminated (about 5 seconds).

1. The **first** value to be displayed is the **salt concentration** in Parts Per Million (PPM). This value is measured by counting the number of flashes of the top 3 lights. In the case of salt, the top light is not used, the next to the top flashes the 1000's digit and the third light flashes the 100's digit in ppm.

Example: 2 flashes/pause/8 flashes/pauseRead: 2,800 PPM

2. The **second** value is the **water temperature** in degrees Fahrenheit. When this is displayed, the second light from the bottom is on. The top light flashes the 100's digit, the next the 10's digit and the next the units of temperature.

Example: 8 flashes/pause/6 flashes/pauseRead: 86 Degrees F

3. When the **third** light from the bottom is on, the **cell voltage** is displayed. The top light is not used. The second light flashes the 10's digit and the third the units of voltage.

Example: 2 flashes/pause/8 flashes/pauseRead: 28 Volts

4. When the **fourth** light is on the **cell current** in amperes is being displayed. The top light displays the 10's digit (not normally used), the next the units and the third the tenths of amps.

Example: 5 flashes/pause/5 flashes/pauseRead: 5.5 Amps

The diagrams below summarize the built-in diagnostic displays.

SALT	TEMPERATURE	VOLTS	AMPS
○	● x100 °F	○	● x10 A
● x1000 ppm	● x10 °F	● x10 V	● x1 A
● x100 ppm	● x1 °F	● x1 V	● x0.1 A
○	○	○	● (Amps)
○	○	● (Volts)	○
○	● (Temperature)	○	○
● (Salt)	○	○	○

Imported to Canada for BIO-LAB CANADA INC. 1005 Copperstone Drive Pickering, ON. L1W 4A5
REGISTRATION NO. 28064 PEST CONTROL PRODUCTS ACT MINERAL SPRINGS SOFT TOUCH MODEL ST48 Chlorine Generating Device
One ST48 unit can treat a maximum of 153,000 Liters of swimming pool water.
Notice to User: This control product is to be used only in accordance with the directions on this label. It is an offence under the Pest Control Products Act to use a control product under unsafe conditions.
For swimming pools, a minimum of 1 ppm of free available chlorine or bromine must be maintained. For spas, a minimum of 3 ppm of free available chlorine or bromine must be maintained.
Controls Bacteria and Algae in Swimming Pool Waters.
Maximum output <u>equivalent</u> to .75 kg of Free Available Chlorine per day
WARNING: Operating the MINERAL SPRINGS SOFT TOUCH MODEL ST48 without water flow through the cell can cause a build up of flammable gases which can result in FIRE OR EXPLOSION
DOMESTIC READ THE LABEL AND THE INSTALLATION AND OPERATION MANUAL BEFORE USING

Imported to Canada for BIO-LAB CANADA INC. 1005 Copperstone Drive Pickering, ON. L1W 4A5
REGISTRATION NO. 28064 PEST CONTROL PRODUCTS ACT MINERAL SPRINGS SOFT TOUCH MODEL ST48 Chlorine Generating Device
One ST48 unit can treat a maximum of 153,000 Liters of swimming pool water.
Notice to User: This control product is to be used only in accordance with the directions on this label. It is an offence under the Pest Control Products Act to use a control product under unsafe conditions.
For swimming pools, a minimum of 1 ppm of free available chlorine or bromine must be maintained. For spas, a minimum of 3 ppm of free available chlorine or bromine must be maintained.
Controls Bacteria and Algae in Swimming Pool Waters.
Maximum output <u>equivalent</u> to .75 kg of Free Available Chlorine per day
WARNING: Operating the MINERAL SPRINGS SOFT TOUCH MODEL ST48 without water flow through the cell can cause a build up of flammable gases which can result in FIRE OR EXPLOSION
DOMESTIC READ THE LABEL AND THE INSTALLATION AND OPERATION MANUAL BEFORE USING

Imported to Canada for BIO-LAB CANADA INC. 1005 Copperstone Drive Pickering, ON. L1W 4A5
REGISTRATION NO. 28064 PEST CONTROL PRODUCTS ACT MINERAL SPRINGS SOFT TOUCH MODEL ST48 Chlorine Generating Device
One ST48 unit can treat a maximum of 153,000 Liters of swimming pool water.
Notice to User: This control product is to be used only in accordance with the directions on this label. It is an offence under the Pest Control Products Act to use a control product under unsafe conditions.
For swimming pools, a minimum of 1 ppm of free available chlorine or bromine must be maintained. For spas, a minimum of 3 ppm of free available chlorine or bromine must be maintained.
Controls Bacteria and Algae in Swimming Pool Waters.
Maximum output <u>equivalent</u> to .75 kg of Free Available Chlorine per day
WARNING: Operating the MINERAL SPRINGS SOFT TOUCH MODEL ST48 without water flow through the cell can cause a build up of flammable gases which can result in FIRE OR EXPLOSION
DOMESTIC READ THE LABEL AND THE INSTALLATION AND OPERATION MANUAL BEFORE USING

Imported to Canada for BIO-LAB CANADA INC. 1005 Copperstone Drive Pickering, ON. L1W 4A5
REGISTRATION NO. 28064 PEST CONTROL PRODUCTS ACT MINERAL SPRINGS SOFT TOUCH MODEL ST48 Chlorine Generating Device
One ST48 unit can treat a maximum of 153,000 Liters of swimming pool water.
Notice to User: This control product is to be used only in accordance with the directions on this label. It is an offence under the Pest Control Products Act to use a control product under unsafe conditions.
For swimming pools, a minimum of 1 ppm of free available chlorine or bromine must be maintained. For spas, a minimum of 3 ppm of free available chlorine or bromine must be maintained.
Controls Bacteria and Algae in Swimming Pool Waters.
Maximum output <u>equivalent</u> to .75 kg of Free Available Chlorine per day
WARNING: Operating the MINERAL SPRINGS SOFT TOUCH MODEL ST48 without water flow through the cell can cause a build up of flammable gases which can result in FIRE OR EXPLOSION
DOMESTIC READ THE LABEL AND THE INSTALLATION AND OPERATION MANUAL BEFORE USING

Cell Model RC-7

This is a replacement cell for the chlorine generating devices MINERAL SPRINGS Model DIGITAL 48 REGISTRATION NUMBER 28063, PEST CONTROL PRODUCTS ACT, and MINERAL SPRINGS Model Soft Touch ST48 REGISTRATION NUMBER 28064, PEST CONTROL PRODUCTS ACT. This cell must only be used on these models of chlorine generating device.

**Read the Label and the Installation and Operation Manual of the chlorine generating device MINERAL SPRINGS Model DIGITAL 48 or MINERAL SPRINGS Model Soft Touch ST48 before using.
BIO-LAB CANADA INC., 1005 Copperstone Drive, Pickering, ON. L1W 4A5**

(MINERAL SPRINGS Cell Label for DIG.ST 48 ENG.)

This label transcript service is offered by the Pest Management Regulatory Agency to provide efficient searching for label information. This service and this information do not replace the official hard-copy label. The PMRA does not provide any guarantee or assurance that the information obtained through this service is accurate, current or correct, and is therefore not liable for any loss resulting, directly or indirectly, from reliance upon this service.